

Process Pump acc. to API610

# PO2

Standard bearing assemblies PO2-1 to PO2-3

Special bearing assemblies are available

Cooled/uncooled



**PUMPIRAN**

Water • Oil • Energy

## Installation Operating Manual

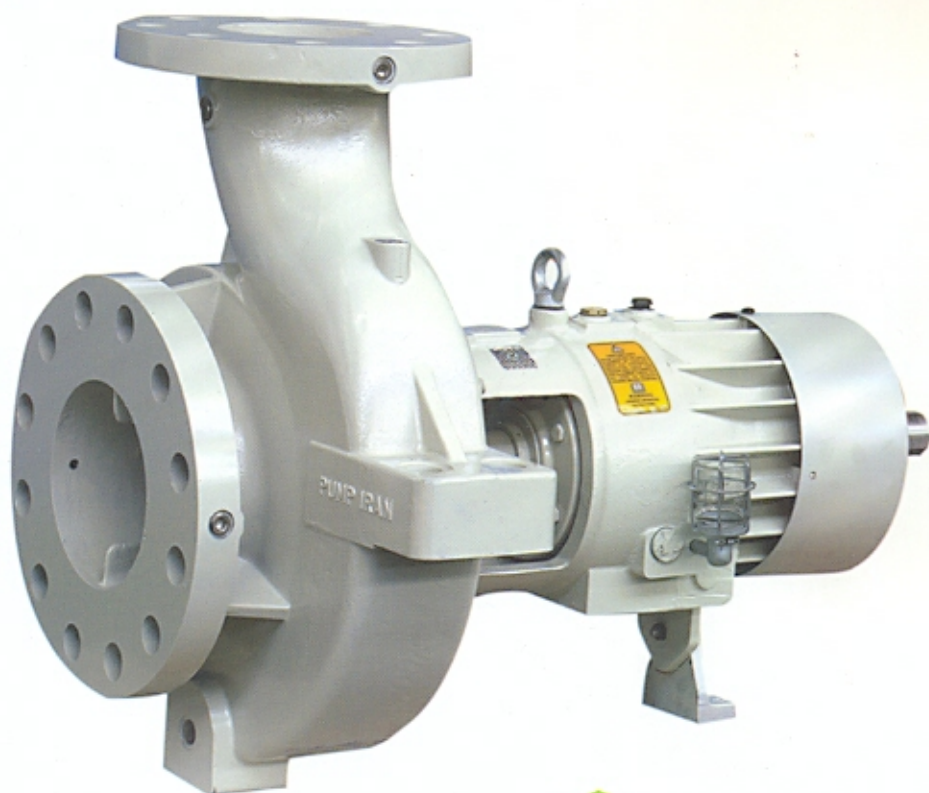

Process Pump acc. to API610

# PO2

Standard bearing assemblies PO2-1 to PO2-5  
Special bearing assemblies are available  
Cooled/non cooled

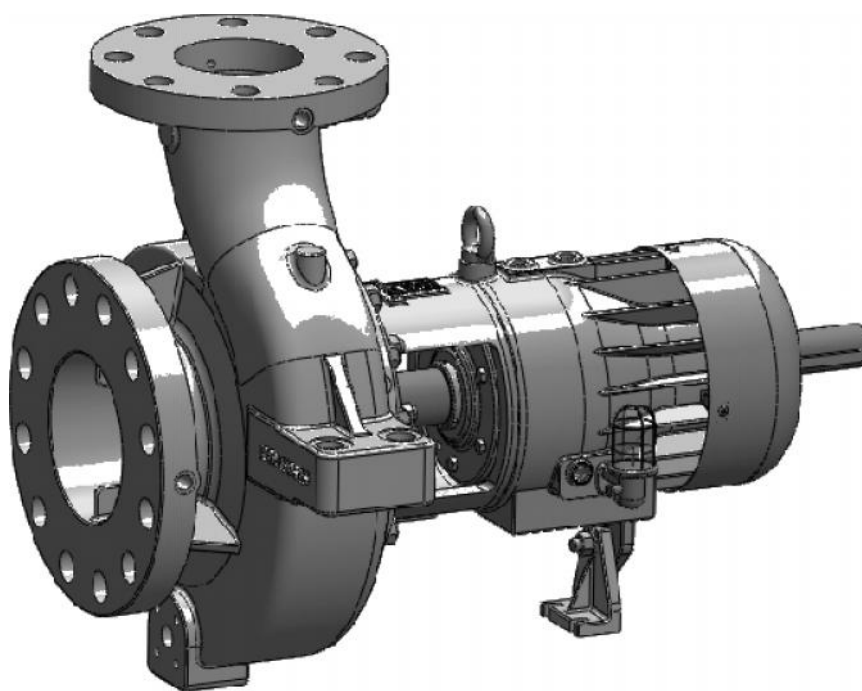

## Installation/Operating Manual

Installation/Operating Manual PO2

Original operating manual

PUMPIRAN CO. TABRIZ

All rights reserved. Contents provided herein must neither be distributed, copied, reproduced, processed for any other purpose, nor otherwise transmitted to a third party without PUMPIRAN's express written consent.

Subject to technical modification without prior notice.

© PUMPIRAN 25.12.2011

## Contents

	<b>Glossary</b> .....	5
<b>1</b>	<b>General</b> .....	6
1.1	Principles .....	6
1.2	Installation of partly completed machinery.....	6
1.3	Target group.....	6
1.4	Other applicable documents.....	6
1.5	Symbols.....	7
<b>2</b>	<b>Safety</b> .....	8
2.1	Key to safety symbols/markings.....	8
2.2	General.....	8
2.3	Intended use.....	9
2.4	Personnel qualification and training.....	9
2.5	Consequences and risks caused by non-compliance with these operating instructions.....	9
2.6	Safety awareness.....	10
2.7	Safety information for the operator/user.....	10
2.8	Safety information for maintenance, inspection and installation work.....	10
2.9	Unauthorized modes of operation.....	11
2.10	Explosion protection.....	11
<b>3</b>	<b>Transport/Temporary Storage/Disposal</b> .....	13
3.1	Transport.....	13
3.2	Storage and preservation.....	14
3.3	Return to supplier.....	15
3.4	Disposal.....	15
<b>4</b>	<b>Description of the Pump (Set)</b> .....	16
4.1	General description.....	16
4.2	Designation.....	16
4.3	Name plate.....	16
4.4	Design details.....	17
4.5	Design a function.....	19
4.6	Noise characteristics.....	20
4.7	Scope of supply.....	20
4.8	Dimensions and weights.....	21
<b>5</b>	<b>Installation at Site</b> .....	21
5.1	Safety regulations.....	21
5.2	Checking the site before installation.....	21
5.3	Installing the pump set.....	22
5.4	Piping .....	23

5.5	Protective equipment .....	26
5.6	Checking the coupling alignment .....	27
5.7	Aligning the pump and motor .....	28
5.8	Electrical connection .....	29
5.9	Checking the direction of rotation .....	30
<b>6</b>	<b>Commissioning/Start-up/Shutdown.....</b>	<b>31</b>
6.1	Commissioning/start-up .....	31
6.2	Operating limits .....	40
6.3	Shutdown/storage/preservation .....	42
6.4	Returning to service after storage .....	43
<b>7</b>	<b>Servicing/Maintenance .....</b>	<b>43</b>
7.1	Safety regulations .....	43
7.2	Servicing/inspection .....	44
7.3	Drainage/disposal .....	48
7.4	Dismantling the pump set .....	49
7.5	Reassembling the pump set .....	52
7.6	Tightening torques .....	55
7.7	Spare parts stock .....	55
<b>8</b>	<b>Trouble-shooting .....</b>	<b>56</b>
<b>9</b>	<b>Related Documents .....</b>	<b>59</b>
9.1	General assembly drawing with list of components .....	59
<b>10</b>	<b>EC Declaration of Conformity .....</b>	<b>61</b>
<b>11</b>	<b>Certificate of Decontamination .....</b>	<b>62</b>
	<b>Index .....</b>	<b>63</b>

## Glossary

### **Back pull-out design**

The complete back pull-out unit can be pulled out without having to remove the pump casing from the piping.

### **Back pull-out unit**

Pump without pump casing; partly completed machinery

### **Certificate of decontamination**

A certificate of decontamination certifies that the pump (set) has been properly drained to eliminate any environmental and health hazards arising from components in contact with the fluid handled.

### **Discharge line**

The line which is connected to the discharge nozzle

### **Hydraulic system**

The part of the pump in which the kinetic energy is converted into pressure energy.

### **Pool of pumps**

Pumps which are purchased and stored independently of their later use

### **Pump**

Machine without drive, additional components or accessories

### **Pump set**

Complete pump set consisting of pump, drive, additional components and accessories

### **Suction lift line/suction head line**

The line which is connected to the suction nozzle

## 1 General

### 1.1 Principles

This manual is supplied as an integral part of the type series and variants indicated on the front cover. It describes the proper and safe use of this equipment in all phases of operation.

The name plate indicates the type series and size, the main operating data, the order number and the order item number. The order number and order item number clearly identify the pump (set) and serve as identification for all further business processes.

In the event of damage, immediately contact your nearest PUMPIRAN service centre immediately to maintain the right to claim under warranty.

Noise characteristics(⇒ Section 4.6 Page 20)

### 1.2 Installation of partly completed machinery

To install partly completed machinery supplied by PUMPIRAN, please refer to the subsections under Servicing/Maintenance. ( ⇒Section 7.5.5 Page 54)

### 1.3 Target group

This manual is aimed at the target group of trained and qualified specialist technical personnel. (⇒Section 2.4 Page 9)

### 1.4 Other applicable documents

**Table 1:** Overview of other applicable documents

Document	Contents
Data sheet	Description of the technical data of the pump(set)
General arrangement drawing/ Outline drawing	Description of mating and installation dimensions for the pump (set)
Drawing of auxiliary connections	Description of auxiliary connections
Hydraulic characteristic curve	Characteristic curves showing head, NPSH required, efficiency and power input
General assembly drawing <sup>1)</sup>	Sectional drawing of the pump
Sub-supplier documentation <sup>1)</sup>	Operating manuals and other documentation of accessories and integrated machinery components
Spare parts lists <sup>1)</sup>	Description of spare parts
Piping layout <sup>1)</sup>	Description of auxiliary piping
List of components <sup>1)</sup>	Description of all pump components

1) If agreed to be included in the scope of supply

## 1.5 Symbols

**Table 2:** Symbols used in this manual

Symbol	Description
✓	Conditions which need to be fulfilled before proceeding with the step-by-step instructions
▷	Safety instructions
	Result of an action
	Cross-references
1. 2.	Step-by-step instructions
	Note Recommendations and important information on how to handle the product











## 2 Safety

All the information contained in this section refers to hazardous situations.

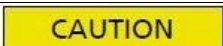
### 2.1 Key to safety symbols/markings

**Table 3:** Definition of safety symbols/markings

Symbol	Description
	<b>DANGER</b> This signal word indicates a high-risk hazard which, if not avoided, will result in death or serious injury.
	<b>WARNING</b> This signal word indicates a medium-risk hazard which, if not avoided, could result in death or serious injury.
	<b>CAUTION</b> This signal word indicates a hazard which, if not avoided, could result in damage to the machine and its functions.
	<b>Explosion protection</b> This symbol identifies information about avoiding explosions in potentially explosive atmospheres in accordance with EC Directive 94/9/EC (ATEX).
	<b>General hazard</b> In conjunction with one of the signal words this symbol indicates a hazard which will or could result in death or serious injury.
	<b>Electrical hazard</b> In conjunction with one of the signal words this symbol indicates a hazard involving electrical voltage and identifies information about protection against electrical voltage.
	<b>Machine damage</b> In conjunction with the signal word <b>CAUTION</b> this symbol indicates a hazard for the machine and its functions.

### 2.2 General

This manual contains general installation, operating and maintenance instructions that must be observed to ensure safe pump operation and prevent injury and damage to property.

The safety instructions in all sections of this manual must be complied with.

This manual must be read and completely understood by the responsible specialist personnel/operators prior to installation and commissioning.

The contents of this manual must be available to the specialist personnel at the site at all times.

Instructions attached directly to the pump must always be complied with and be kept in a perfectly legible condition at all times. This applies to, for example:

- Arrow indicating the direction of rotation
- Markings for connections
- Name plate

The operator is responsible for meeting all local regulations which are not taken into account in this manual.

### **2.3 Intended use**

The pump (set) must only be operated within the operating limits described in the other applicable documents.

Only operate pumps/pump sets which are in perfect technical condition.

Do not operate partially assembled pumps/pump sets.

The pump must only be used to handle the fluids specified in the data sheet or product literature of the respective design variant.

Never operate the pump without the fluid to be handled.

Observe the minimum flow rates indicated in the data sheet or product literature (to prevent overheating, bearing damage, etc).

Observe the maximum flow rates indicated in the data sheet or product literature (to prevent overheating, mechanical seal damage, cavitation damage, bearing damage, etc).

Do not throttle the flow rate on the suction side of the pump (to prevent cavitation damage).

Consult the manufacturer about any use or mode of operation not described in the data sheet or product literature.

### **Prevention of foreseeable misuse**

Never open discharge-side shut-off elements further than permitted.

– The maximum flow rate specified in the data sheet or product literature would be exceeded.

– Risk of cavitation damage

Never exceed the permissible operating limits specified in the data sheet or product literature regarding pressure, temperature, etc.

Observe all safety information and instructions in this manual.

### **2.4 Personnel qualification and training**

All personnel involved must be fully qualified to install, operate, maintain and inspect the machinery this manual refers to.

The responsibilities, competence and supervision of all personnel involved in installation, operation, maintenance and inspection must be clearly defined by the operator.

Deficits in knowledge must be rectified by sufficiently trained specialist personnel training and instructing the personnel who will carry out the respective tasks. If required, the operator can commission the manufacturer/supplier to train the personnel.

Training on the pump (set) must always be supervised by technical specialist personnel.

### **2.5 Consequences and risks caused by non-compliance with these operating instructions**

Non-compliance with these operating instructions will lead to forfeiture of warranty cover and of any and all rights to claims for damages.

Non-compliance can, for example, have the following consequences:

- Hazards to persons due to electrical, thermal, mechanical and chemical effects and explosions
- Failure of important product functions
- Failure of prescribed maintenance and servicing practices
- Hazard to the environment due to leakage of hazardous substances

### **2.6 Safety awareness**

In addition to the safety information contained in this manual and the intended use, the following safety regulations shall be complied with:

- Accident prevention, health and safety regulations
- Explosion protection regulations
- Safety regulations for handling hazardous substances
- Applicable standards and laws

### **2.7 Safety information for the operator/user**

The operator shall fit contact guards for hot, cold or moving parts and check that the guards function properly.

Do not remove the contact guard while the pump is running.

Connect an earth conductor to the metal jacket if the fluid handled is electro-statically charged.

Provide the personnel with protective equipment and make sure it is used.

Contain leakages (e.g. at the shaft seal) of hazardous fluids handled (e.g. explosive, toxic, hot) so as to avoid any danger to persons and the environment.

Adhere to all relevant laws.

Eliminate all electrical hazards. (In this respect refer to the applicable national safety regulations and/or regulations issued by the local energy supply companies.)

### **2.8 Safety information for maintenance, inspection and installation work**

Modifications or alterations of the pump are only permitted with the manufacturer's prior consent.

Use only original spare parts or parts authorised by the manufacturer. The use of other parts can invalidate any liability of the manufacturer for consequential damage.

The operator ensures that all maintenance, inspection and installation work is performed by authorised, qualified specialist personnel who are thoroughly familiar with the manual.

Carry out work on the pump (set) during standstill only.

The pump casing must have cooled down to ambient temperature.

Pump pressure must have been released and the pump must have been drained.

When taking the pump set out of service always adhere to the procedure described in the manual. (⇒ Section 6.1.13 Page 39)

Decontaminate pumps which handle fluids posing a health hazard. (⇒Section 7.3 Page 48)

As soon as the work is complete, re-install and/or re-activate any safety-relevant and protective devices. Before returning the product to service, observe all instructions on commissioning. (⇒Section 6.1 Page 31)

## 2.9 Unauthorised modes of operation

Never operate the pump (set) outside the limits stated in the data sheet and in this manual.

The warranty relating to the operating reliability and safety of the supplied pump (set) is only valid if the equipment is used in accordance with its intended use. (⇒ Section 2.3 Page 9)



## 2.10 Explosion protection

Always observe the instructions on explosion protection given in this section when operating the pump in potentially explosive atmospheres.



Only pumps/pump sets marked as explosion-proof and identified as such in the data sheet may be used in potentially explosive atmospheres.

Special conditions apply to the operation of explosion-proof pump sets to EC Directive 94/9/EC (ATEX).

Especially adhere to the sections in this manual marked with the Ex symbol and the following sections (⇒ Section 2.10.1 Page 11) to (⇒ Section 2.10.4 Page 13). The explosion-proof status of the pump set is only assured if the pump set is used in accordance with its intended use.

Never operate the pump (set) outside the limits stated in the data sheet and on the name plate.

Prevent impermissible modes of operation at all times.

### 2.10.1 Marking

<b>Pump</b>	The marking on the pump refers to the pump only. Example of such marking: II 2 G c TX Refer to the Temperature limits table for the temperatures permitted for the individual pump variants. (⇒ Section 2.10.2 Page 11)
<b>Shaft coupling</b>	An EC manufacturer's declaration is required for the shaft coupling; the shaft coupling must be marked accordingly.
<b>Motor</b>	The motor must be considered separately.

### 2.10.2 Temperature limits

In normal pump operation, the highest temperatures are to be expected on the surface of the pump casing, at the shaft seal and in the bearing areas.

The surface temperature at the pump casing corresponds to the temperature of the fluid handled. If the pump is heated in addition, the operator of the system is responsible for observing the specified temperature classes and fluid temperature (operating temperature).

The table below lists the temperature classes and the resulting theoretical temperature limits of the fluid handled (a possible temperature rise in the shaft seal area has already been taken into account).

The temperature class specifies the maximum permissible temperature at the surface of the pump set during operation. For the permissible operating temperature of the pump in question refer to the data sheet.

**Table 4: Temperature limits**

Temperature class as per EN 13463-1	Maximum permissible fluid temperature
T1	Maximum 400 °C <sup>2)</sup>
T2	280 °C
T3	185 °C
T4	120 °C
T5	85 °C
T6	Only after consultation with the manufacturer

**Temperature class T5** Based on an ambient temperature of 40 °C and proper maintenance and operation, compliance with temperature class T5 is warranted in the area of the rolling element bearings. If the ambient temperature exceeds 40 °C, contact the manufacturer.

**Temperature class T6** A special design is required to comply with the requirements of temperature class T6 in the bearing area. Misuse, malfunctions or non-compliance with the instructions may result in substantially higher temperatures. If the pump is to be operated at a higher temperature, the data sheet is missing or if the pump is part of a pool of pumps, contact PUMPIRAN for the maximum permissible operating temperature.

### 2.10.2 Monitoring equipment

The pump (set) must only be operated within the limits specified in the data sheet and on the name plate.

If the system operator cannot warrant compliance with these operating limits, appropriate monitoring devices must be used.

Check whether monitoring equipment is required to ensure that the pump set functions properly.

Contact PUMPIRAN for further information on monitoring equipment.

2) Depending on the material variant

### 2.10.3 Operating limits



The minimum flows refer to water and water-like fluids. Longer operating periods with these fluids and at the flow rates indicated will not cause an additional increase in the temperatures on the pump surface. However, if the physical properties of the fluids handled are different from water, it is essential to check if an additional heat build-up may occur and if the minimum flow rate must therefore be increased. The calculation formula can be used to check if an additional heat build-up may lead to a hazardous temperature increase at the pump surface.

### 2.10.4 Operating limits

The minimum flows indicated in section (⇒Section 6.2.3 Page 41) refer to water and water-like fluids. Longer operating periods with these fluids and at the flow rates indicated will not cause an additional increase in the temperatures on the pump surface. However, if the physical properties of the fluids handled are different from water, it is essential to check if an additional heat build-up may occur and if the minimum flow rate must therefore be increased. The calculation formula in (⇒Section 6.2.3 Page 41) can be used to check if an additional heat build-up may lead to a hazardous temperature increase at the pump surface.

## 3 Transport/Temporary Storage/Disposal

### 3.1 Transport

	 <b>DANGER</b>
	<p><b>The pump (set) could slip out of the suspension arrangement</b> Danger to life from falling parts!</p> <ul style="list-style-type: none"> <li>▷ Always transport the pump (set) in horizontal position.</li> <li>▷ Never attach the suspension arrangement to the free shaft end or the motor eyebolt.</li> <li>▷ Refer to the weights given in the general arrangement drawing.</li> <li>▷ Observe the local accident prevention regulations.</li> <li>▷ Use suitable, permitted lifting tackle, e.g. self-tightening lifting tongs.</li> </ul>

To transport the pump/pump set suspend it from the lifting tackle as follows.

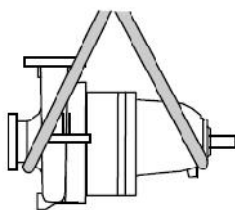

**Fig. 1:** Transporting a pump

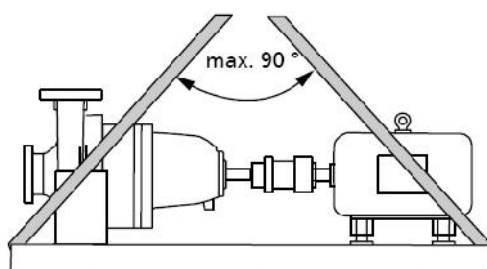

**Fig. 2:** Transporting a complete pump set

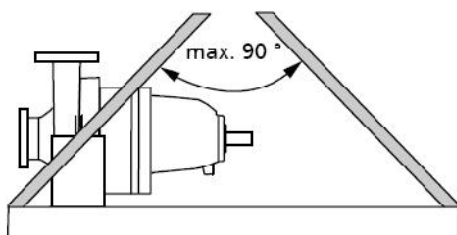

**Fig. 3:** Transporting a pump on base plate

### 3.2 Storage and preservation

If commissioning is to take place some time after delivery, we recommend that the following measures be taken for pump (set) storage.

	<b>CAUTION</b>
	<p><b>Damage during storage by humidity, dirt, or vermin</b> Corrosion/contamination of the pump (set)!</p> <p>▷ For outdoor storage cover the pump (set) or the packaged pump (set) and accessories with waterproof material.</p>

	<b>CAUTION</b>
	<p><b>Wet, contaminated or damaged openings and connections</b> Leakage or damage to the pump set!</p> <p>▷ Only remove caps/covers from the openings of the pump set at the time of installation.</p>

Store the pump (set) in a dry, protected room where the atmospheric humidity is as constant as possible.

Rotate the shaft by hand once a month, e.g. via the motor fan.

If properly stored indoors, the pump set is protected for a maximum of 12 months. New pumps/pump sets are supplied by our factory duly prepared for storage.

For storing a pump (set) which has already been operated, observe the instructions in (⇒ Section 6.3.1 Page 42) .

### 3.3 Return to supplier

1. Drain the pump as per operating instructions. (⇒ Section 7.3 Page 48)

2. Always flush and clean the pump, particularly if it has been used for handling noxious, explosive, hot or other hazardous fluids.

3. If the fluids handled by the pump leave residues which might lead to corrosion damage when coming into contact with atmospheric humidity, or which might ignite when coming into contact with oxygen, the pump set must also be neutralised, and anhydrous gas must be blown through the pump for drying purposes.

4. Always complete and enclose a certificate of decontamination when returning the pump (set). (⇒Section 11 Page 62)

Always indicate the safety and decontamination measures taken.

	<b>NOTE</b>
	<p>If required, a blank certificate of decontamination can be downloaded from the PUMPIRAN web. site at: <a href="http://www.PUMPIRAN.com">www.PUMPIRAN.com</a></p>

### 3.4 Disposal

	<b>⚠ WARNING</b>
	<p><b>Fluids posing a health hazard</b> Hazardous to persons and the environment!</p> <ul style="list-style-type: none"> <li>▷ Collect and properly dispose of flushing liquid and any fluid residues.</li> <li>▷ Wear safety clothing and a protective mask, if required.</li> <li>▷ Observe all legal regulations on the disposal of fluids posing a health hazard.</li> </ul>

1. Dismantle the pump (set).

Collect greases and other lubricants during dismantling.

2. Separate and sort the pump materials, e.g. by:

- Metals
- Plastics
- Electronic waste
- Greases and other lubricants



3. Dispose of materials in acc. with local regulations or in another controlled manner.

## 4 Description of the Pump (Set)

### 4.1 General description

Process pump to API 610

Pump for handling the large variety of crude oil products in refineries as well as in the chemical and petrochemical industry.

### 4.2 Designation

**Example :** PO2 150-315(19)-GG-1

**Table 5:** Key to the designation

Code	Description
PO2	Type series
150	Nominal discharge nozzle diameter [mm]
315	Nominal impeller diameter [mm]
GG	Material variant to API 610
1	Type of sealing

### 4.3 Name plate

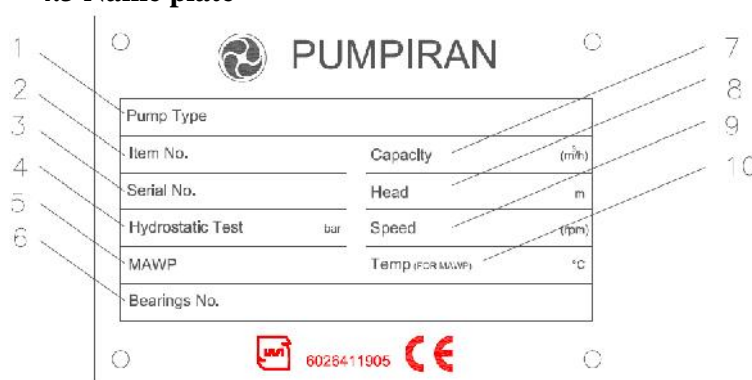

**Fig. 4:** Name plate

1	Pump Type	6	Bearing No.
2	Item number(tag No.)	7	Capacity
3	Serial No.	8	Head
4	Hydrostatic Test	9	Speed
5	Maximum available Working Pressure	10	Temperature

#### 4.4 Design details

##### Design

Volute casing pump

Horizontal installation

Back pull-out design

Single-stage

Fulfills technical requirements to API<sup>3)</sup> 610, 10th edition/ISO 13709

##### Pump casing

Volute casing with integrally cast pump feet

Centre-line pump feet

Single or double volute, depending on the pump size

Radially split volute casing

Axial inlet nozzle, tangential discharge nozzle pointing vertically upwards.  
(From DN 80 / from impeller diameter 315 / pump size 80-315: radial discharge nozzle pointing vertically upwards)

Volute casing with casing wear ring

Casing cover (with casing wear ring, as required)

##### Optional:

Casing cover with heating and/or cooling chamber, as required

##### Impeller type

Closed radial impeller

Impeller with impeller wear ring on the suction side  
(if required also on the discharge side).

Sealing gap and balancing holes balance axial force

##### Shaft Seal

Cartridge seal to API<sup>4)</sup> 682



##### NOTE

Seal designs and types other than specified herein shall only be used in exceptional cases and only after prior consultation with the manufacturer.

##### Bearing

Un cooled

##### Optional:

Cooled bearing bracket

3) American Petroleum Institute

4) American Petroleum Institute

## Design specification

### Motor-end bearing:

Fixed bearing  
 Paired angular contact ball bearing  
 Axial movement of the rotor limited to maximum 0.5 mm  
 Oil bath lubrication  
**Optional:** Oil mist lubrication

### Pump-end bearing:

Radial bearing  
 Cylindrical roller bearing  
 Absorbs radial loads only  
 Oil bath lubrication  
**Optional:** Oil mist lubrication

## Bearings used

**Table 6:** Standard bearing assembly

Bearing bracket	Rolling element bearing	
	Pump end	Motor end
1	NU309 C3	7309 C3
2	NU311 C3	7311 BECBM C3
3	NU313 C3	7313 BECBM C3

## Oil quantity

**Table 7:** Oil quantity

Bearing bracket	Oil quantity bearing bracket [ l ]
1	0.9
2	1.8
3	2.5

## 4.5 Design and function

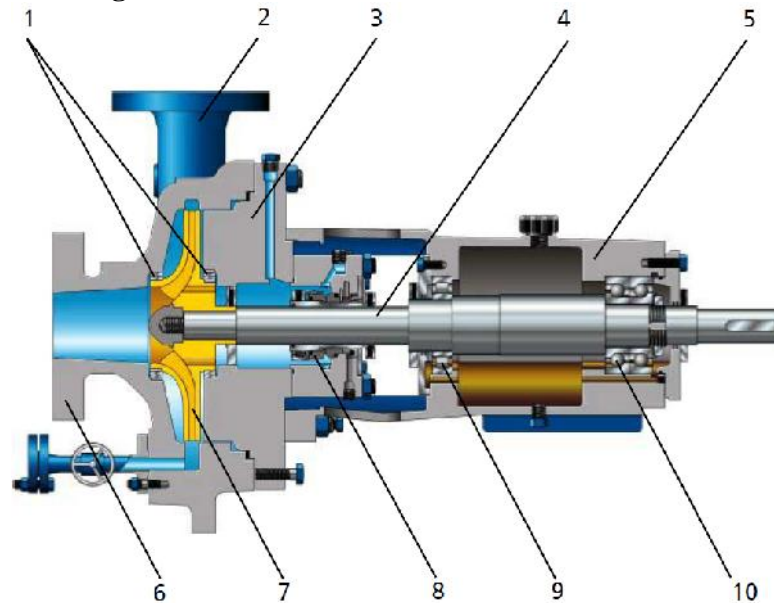

1	Clearance gap	2	Discharge nozzle
3	Casing cover	4	Shaft
5	Bearing bracket	6	Suction nozzle
7	Impeller	8	Shaft seal
9	Rolling element bearing, pump end	10	Rolling element bearing, motor end

**Design** The pump is designed with an axial fluid inlet and a radial or tangential outlet. The hydraulic system runs in its own bearings and is connected to the motor by a shaft coupling.

**Function** The fluid enters the pump axially via a suction nozzle (6) and is accelerated by the rotating impeller (7), which causes a cylindrical flow towards the outside of the pump. The flow profile of the pump casing converts the kinetic energy of the fluid into pressure energy. The fluid is pumped to the discharge nozzle (2), where it leaves the pump. The clearance gap (1) prevents any fluid from flowing back from the pump casing into the inlet. At the rear side of the impeller, the shaft (4) enters the casing via the casing cover (3). The shaft passage through the pump casing is sealed towards the atmosphere with a shaft seal (8). The shaft runs in rolling element bearings (9 and 10), which are supported by a bearing bracket (5) and linked with the casing cover.

**Sealing** The pump is sealed by a standardised mechanical seal.

## 4.6 Noise characteristics

**Table 8:** Surface sound pressure level  $L_{pA}$  <sup>5) 6)</sup>

Rated power input $P_N$ [kW]	Pump			Pump Set		
	2900 rpm [dB]	1450 rpm [dB]	960 rpm 760 rpm [dB]	2900 rpm [dB]	1450 rpm [dB]	960 rpm 760 rpm [dB]
1	54	53	52	63	58	56
2	56	55	53	66	60	58
3	57	56	55	68	62	60
4	59	58	56	69	63	61
6	61	59	58	71	65	62
8	62	61	59	72	66	64
11	64	63	61	74	68	65
15	66	65	63	75	69	67
19	67	66	64	76	70	68
22	68	67	65	77	71	68
30	70	68	66	78	72	70
37	71	70	67	79	73	70
45	72	71	68	80	74	71
55	73	72	69	80	74	72
75	75	73	71	81	76	73
90	76	74	71	82	76	73
110	77	75	72	82	77	74
132	78	76	73	83	77	75
160	79	77	74	84	78	75
200	80	78	75	84	79	76
250	81	79	-	85	80	-

### 4.7 Scope of supply

Depending on the model, the following items are included in the scope of supply:

Pump

**Coupling** Rigid multiple-disc clutch with spacer sleeve

**Contact guard** Coupling guard to EN 294

**Base plate** Welded base plate for the complete unit (pump and motor), in torsion-resistant design

**Special accessories** As required

5) Spatial average; as per ISO 3744 and EN 12639; valid for operating range  $Q/Q_{opt} = 0.8 - 1.1$  and non-cavitating pump operation. If noise levels are to be guaranteed: Add +3 dB for measuring and constructional tolerance.



6) Increase for 60 Hz operation: 3500 rpm+3 dB; 1750 rpm +1 dB; 1160 rpm:±0 dB

## 4.8 Dimensions and weights

For dimensions and weights please refer to the general arrangement drawing/outline drawing of the pump (set).



## 5 Installation at Site

### 5.1 Safety regulations

  	 <b>DANGER</b>
	<p><b>Improper installation in potentially explosive atmospheres</b> Explosion hazard! Damage to the pump set!</p> <ul style="list-style-type: none"> <li>▷ Comply with the applicable local explosion protection regulations.</li> <li>▷ Observe the information in the data sheet and on the name plates of pump and motor.</li> </ul>

### 5.2 Checking the site before installation

Place of installation

	 <b>WARNING</b>
	<p><b>Installation on foundations which are unsecured and cannot support the load</b> Personal injury and damage to property!</p> <ul style="list-style-type: none"> <li>▷ Make sure the foundation concrete is of sufficient strength (min. X0 to DIN 1045).</li> <li>▷ Only place the pump set on a foundation whose concrete has set firmly.</li> <li>▷ Only place the pump set on a horizontal and level surface.</li> <li>▷ Refer to the weights given in the general arrangement drawing.</li> </ul>

#### 1. Check the structural requirements.

All structural work required must have been prepared in accordance with the dimensions stated in the outline drawing/general arrangement drawing.

## 5.3 Installing the pump set

Always install the pump set in horizontal position.

	<b>⚠ DANGER</b>
	<p><b>Excessive temperatures due to improper installation</b> Explosion hazard!</p> <p>▷ Install the pump in horizontal position to ensure self-venting of the pump.</p>

### 5.3.1 Installation on a foundation

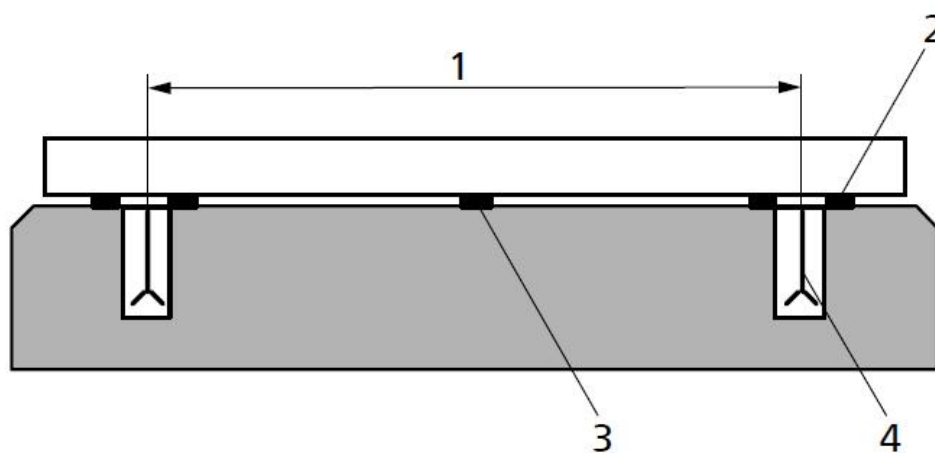

**Fig. 5:** Fitting the shims

1	Bolt-to-bolt clearance	2	Shim
3	Shim if clearance > 800 mm	4	Foundation bolt

The foundation has the required strength and characteristics.

The foundation has been prepared in accordance with the dimensions stated on the outline drawing / general arrangement drawing.

1. Position the pump on the foundation and use a spirit level to align shaft and discharge nozzle. Permissible deviation: 0.2 mm/m.
2. If required, use shims (2) to adjust the height.  
Fit shims between the base plate/foundation frame and the foundation itself; always insert them to the left and right of the foundation bolts and in close proximity to these bolts.  
For a bolt-to-bolt clearance > 800 mm, insert additional shims halfway between the adjoining holes.  
All shims must lie perfectly flush.
3. Insert the foundation bolts (4) into the holes provided.
4. Use concrete to set the foundation bolts (4) into the foundation.
5. Wait until the concrete has set firmly, then align the base plate.
6. Tighten the foundation bolts (4) evenly and firmly.



7. Grout the base plate using low-shrinkage concrete with a standard particle size and a water/concrete ratio of 0.5.  
Produce flow ability with the help of a solvent.  
Perform secondary treatment of the concrete to DIN 1045.

	<b>NOTE</b>
	For low-noise operation the pump set can be mounted on vibration dampers upon confirmation by the manufacturer. In this case, only fasten the flexible elements at the base plate after the piping has been connected.

	<b>NOTE</b>
	Expansion joints can be fitted between pump and suction/discharge line.

## 5.4 Piping

### 5.4.1 Connecting the piping

	 <b>DANGER</b>
	<p><b>Excessive loads acting on the pump nozzles</b> Danger to life from leakage of hot, toxic, corrosive or flammable fluids!</p> <ul style="list-style-type: none"> <li>▷ Do not use the pump as an anchorage point for the piping.</li> <li>▷ Anchor the pipelines in close proximity to the pump and connect them without transmitting any stresses or strains.</li> <li>▷ Observe the permissible forces and moments at the pump nozzles. (⇒ Section 5.4.2 Page 25)</li> <li>▷ Take appropriate measures to compensate thermal expansion of the piping.</li> </ul>

	<b>CAUTION</b>
	<p><b>Incorrect earthing during welding work at the piping</b> Destruction of rolling element bearings (pitting effect)!</p> <ul style="list-style-type: none"> <li>▷ Never earth the electric welding equipment on the pump or base plate.</li> <li>▷ Prevent current flowing through the rolling element bearings.</li> </ul>

	<b>NOTE</b>
	It is recommended to install check and shut-off elements in the system, depending on the type of plant and pump. However, such elements must not obstruct proper drainage or hinder disassembly of the pump.



The suction lift line/suction head line has been laid with a rising/downward slope towards the pump.

The nominal diameters of the pipelines are at least equal to the nominal diameters of the pump nozzles.

To prevent excessive pressure losses, adapters to larger diameters have a diffuser angle of approximately 8°.

The pipelines have been anchored in close proximity to the pump and connected without transmitting any stresses or strains.

1. Thoroughly clean, flush and blow through all vessels, pipelines and connections (especially of new installations).
2. Before installing the pump in the piping, remove the flange covers on the suction and discharge nozzles of the pump.

	<b>CAUTION</b>
	<b>Welding beads, scale and other impurities in the piping</b> Damage to the pump!
	▷ Free the piping from any impurities.
	▷ If necessary, install a filter.
	▷ Observe the instructions in (⇔ Section 7.2.2.3 Page 47).

3. If required, install a filter in the piping (see drawing: Filter in the piping).

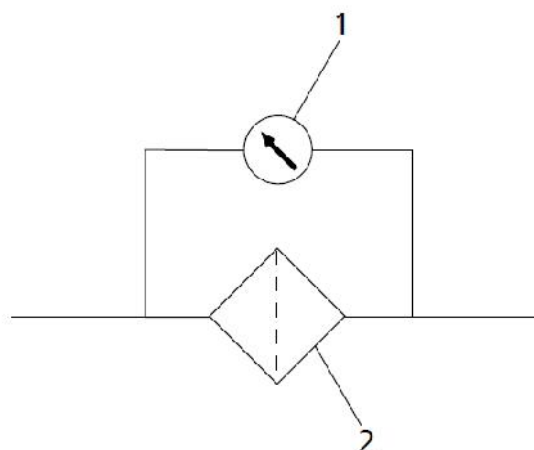

**Fig. 6:** Filter in the piping

1	Differential pressure gauge	2	Filter
---	-----------------------------	---	--------

	<b>NOTE</b>
	Use a filter with laid-in wire mesh (mesh width 0.5 mm, wire diameter 0.25 mm) of corrosion-resistant material.
	Use a filter three times the diameter of the piping. Conical filters have proved suitable.

4. Connect the pump nozzles with the piping.

	<b>CAUTION</b>
	<p><b>Aggressive flushing and pickling agents</b> Damage to the pump!</p> <p>▷ Match the cleaning operation mode and duration for flushing and pickling service to the casing and seal materials used.</p>

### 5.4.2 Permissible forces and moments at the pump nozzles

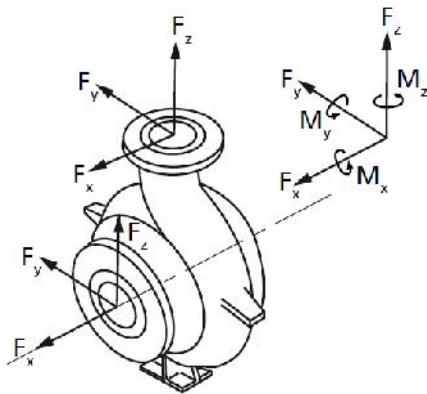

PO2 pumps are designed to withstand twice the piping forces and moments required by API 610, table 9.

**Table 9:** Forces and moments at the pump nozzles

Pump size	Suction nozzle								Discharge nozzle							
	Forces [N]				Moments [N.m]				Forces [N]				Moments [N.m]			
	$F_x$	$F_y$	$F_z$	$F_{res}$	$M_x$	$M_y$	$M_z$	$M_{res}$	$F_x$	$F_y$	$F_z$	$F_{res}$	$M_x$	$M_y$	$M_z$	$M_{res}$
PO2 40-120	1780	1430	1160	2560	920	460	710	1250	1430	1160	1780	2560	920	460	710	1250
PO2 40-125	1780	1430	1160	2560	920	460	710	1250	1430	1160	1780	2560	920	460	710	1250
PO2 40-150	1780	1430	1160	2560	920	460	710	1250	1430	1160	1780	2560	920	460	710	1250
PO2 40-160	1780	1430	1160	2560	920	460	710	1250	1430	1160	1780	2560	920	460	710	1250
PO2 40-190	1780	1430	1160	2560	920	460	710	1250	1430	1160	1780	2560	920	460	710	1250
PO2 40-200	1780	1430	1160	2560	920	460	710	1250	1430	1160	1780	2560	920	460	710	1250
PO2 40-240	1780	1430	1160	2560	920	460	710	1250	1430	1160	1780	2560	920	460	710	1250
PO2 40-250	1780	1430	1160	2560	920	460	710	1250	1430	1160	1780	2560	920	460	710	1250
PO2 40-315	1780	1430	1160	2560	920	460	710	1250	1430	1160	1780	2560	920	460	710	1250
PO2 50-125	2670	2140	1780	3860	1900	950	1440	2570	1430	1160	1780	2560	920	460	710	1250
PO2 50-160	2670	2140	1780	3860	1900	950	1440	2570	1430	1160	1780	2560	920	460	710	1250
PO2 50-200	2670	2140	1780	3860	1900	950	1440	2570	1430	1160	1780	2560	920	460	710	1250
PO2 50-250	2670	2140	1780	3860	1900	950	1440	2570	1430	1160	1780	2560	920	460	710	1250
PO2 50-315	2670	2140	1780	3860	1900	950	1440	2570	1430	1160	1780	2560	920	460	710	1250
PO2 80-120	3560	2840	2320	5110	2660	1360	2010	3600	2140	1780	2670	3860	1900	950	1440	2570
PO2 80-150	3560	2840	2320	5110	2660	1360	2010	3600	2140	1780	2670	3860	1900	950	1440	2570
PO2 80-160	3560	2840	2320	5110	2660	1360	2010	3600	2140	1780	2670	3860	1900	950	1440	2570
PO2 80-190	3560	2840	2320	5110	2660	1360	2010	3600	2140	1780	2670	3860	1900	950	1440	2570

Pump size	Suction nozzle								Discharge nozzle							
	Forces [N]				Moments [N.m]				Forces [N]				Moments [N.m]			
	F <sub>x</sub>	F <sub>y</sub>	F <sub>z</sub>	F <sub>res</sub>	M <sub>x</sub>	M <sub>y</sub>	M <sub>z</sub>	M <sub>res</sub>	F <sub>x</sub>	F <sub>y</sub>	F <sub>z</sub>	F <sub>res</sub>	M <sub>x</sub>	M <sub>y</sub>	M <sub>z</sub>	M <sub>res</sub>
PO2 80-200	3560	2840	2320	5110	2660	1360	2010	3600	2140	1780	2670	3860	1900	950	1440	2570
PO2 80-240	3560	2840	2320	5110	2660	1360	2010	3600	2140	1780	2670	3860	1900	950	1440	2570
PO2 80-250	3560	2840	2320	5110	2660	1360	2010	3600	2140	1780	2670	3860	1900	950	1440	2570
PO2 80-310	3560	2840	2320	5110	2660	1360	2010	3600	2140	1780	2670	3860	1900	950	1440	2570
PO2 80-315	3560	2840	2320	5110	2660	1360	2010	3600	2140	1780	2670	3860	1900	950	1440	2570
PO2 80-400	3560	2840	2320	5110	2660	1360	2010	3600	2140	1780	2670	3860	1900	950	1440	2570
PO2 100-160	6230	4980	4090	8960	4610	2360	3530	6270	2850	2310	3560	5110	2660	1360	2010	3600
PO2 100-200	6230	4980	4090	8960	4610	2360	3530	6270	2850	2310	3560	5110	2660	1360	2010	3600
PO2 100-250	6230	4980	4090	8960	4610	2360	3530	6270	2850	2310	3560	5110	2660	1360	2010	3600
PO2 100-315	6230	4980	4090	8960	4610	2360	3530	6270	2850	2310	3560	5110	2660	1360	2010	3600
PO2 100-400	6230	4980	4090	8960	4610	2360	3530	6270	2850	2310	3560	5110	2660	1360	2010	3600
PO2 150-190	9790	7560	6230	13850	7050	3530	5150	9420	4980	4100	6230	8970	4610	2360	3530	6270
PO2 150-200	9790	7560	6230	13850	7050	3530	5150	9420	4980	4100	6230	8970	4610	2360	3530	6270
PO2 150-240	9790	7560	6230	13850	7050	3530	5150	9420	4980	4100	6230	8970	4610	2360	3530	6270
PO2 150-250	9790	7560	6230	13850	7050	3530	5150	9420	4980	4100	6230	8970	4610	2360	3530	6270
PO2 150-310	9790	7560	6230	13850	7050	3530	5150	9420	4980	4100	6230	8970	4610	2360	3530	6270
PO2 150-315	9790	7560	6230	13850	7050	3530	5150	9420	4980	4100	6230	8970	4610	2360	3530	6270
PO2 150-390	9790	7560	6230	13850	7050	3530	5150	9420	4980	4100	6230	8970	4610	2360	3530	6270
PO2 150-400	9790	7560	6230	13850	7050	3530	5150	9420	4980	4100	6230	8970	4610	2360	3530	6270
PO2 150-490	9790	7560	6230	13850	7050	3530	5150	9420	4980	4100	6230	8970	4610	2360	3530	6270
PO2 300-500	17800	14240	11560	25560	12740	6240	9500	17080	13340	10680	16000	23400	12200	5960	9220	16420

### 5.4.3 Auxiliary connections



**CAUTION**

**Failure to use or incorrect use of auxiliary connections (e.g. barrier fluid, flushing liquid, etc.)**  
 Malfunction of the pump!

- ▷ Refer to the general arrangement drawing, the piping layout and pump markings (if any) for the dimensions and locations of auxiliary connections.
- ▷ Use the auxiliary connections provided.

### 5.5 Protective equipment



**⚠ WARNING**

**The volute casing and casing/discharge cover take on the same temperature as the fluid handled**  
 Risk of burning!

- ▷ Insulate the volute casing.
- ▷ Fit protective equipment.

	<b>⚠ DANGER</b>
	<p><b>An explosive atmosphere forms due to insufficient venting</b> Explosion hazard!</p> <ul style="list-style-type: none"> <li>▷ Make sure the space between the casing cover/discharge cover and the bearing cover is sufficiently vented.</li> <li>▷ Never close or cover the perforation of the bearing bracket guards (e.g. by insulation).</li> </ul>

	<b>CAUTION</b>
	<p><b>Heat build-up in the bearing bracket</b> Damage to the bearing!</p> <ul style="list-style-type: none"> <li>▷ Never insulate the casing cover and the bearing bracket.</li> </ul>

## 5.6 Checking the coupling alignment

	<b>⚠ DANGER</b>
	<p><b>Inadmissible temperatures at the coupling or bearings due to misalignment of the coupling</b> Explosion hazard!</p> <ul style="list-style-type: none"> <li>▷ Make sure that the coupling is correctly aligned at all times.</li> </ul>

	<b>CAUTION</b>
	<p><b>Misalignment of pump and motor shafts</b> Damage to pump, motor and coupling!</p> <ul style="list-style-type: none"> <li>▷ Always check the coupling after the pump has been installed and connected to the piping.</li> <li>▷ Also check the coupling of pump sets supplied with pump and motor mounted on the same base plate.</li> </ul>

Checking the coupling alignment with a dial gauge

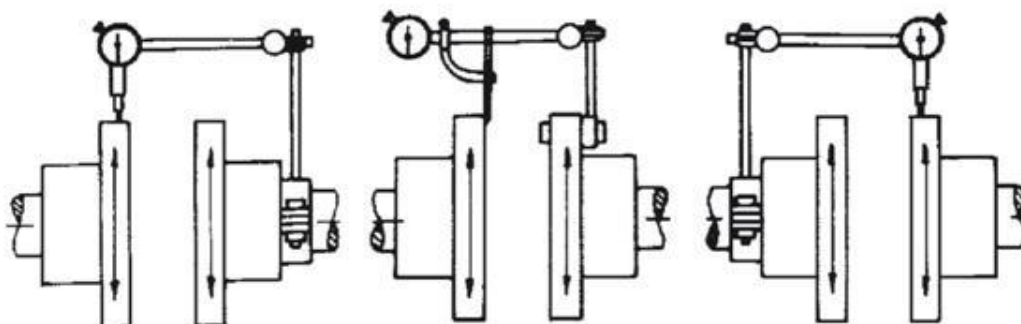

**Fig. 7:** Checking the spacer-type coupling with a dial gauge

1. Mark the installation position of the coupling by dotting marks (balancing condition).
2. Remove the coupling spacer

**NOTE**

While the pump's coupling is disengaged, also check the direction of rotation. (⇒ Section 5.9 Page 30)

3. Check the alignment of the coupling halves with a dial gauge (see drawing "Checking the spacer-type coupling with a dial gauge").  
Admissible run-out of coupling face (axial) maximum 0.1 mm.  
Admissible radial deviation, measured over the complete circumference, maximum 0.2 mm.

**5.7 Aligning the pump and motor**

After having installed the pump set and connected the piping, check the coupling alignment and, if required, re-align the pump set (with the motor). Any differences in shaft centre height between the pump and the motor are compensated by means of shims.

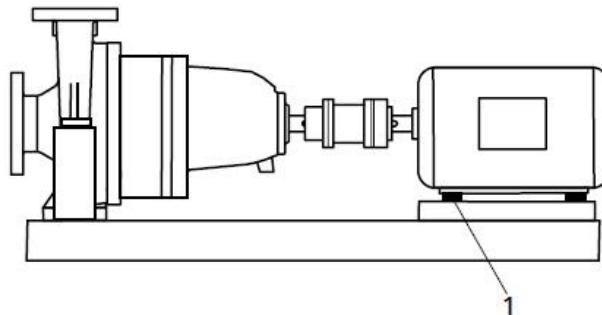

**Fig. 8:** Pump set with shim

1	Shim
---	------

The coupling guard and step guard, if any, have been removed.

1. Check the coupling alignment.
2. Unscrew the hexagon head bolts at the motor.
3. Insert shims underneath the motor feet until the difference in shaft centre height has been compensated.
4. Re-tighten the hexagon head bolts.
5. Check that the coupling and shaft can easily be rotated by hand.

	<b>⚠ WARNING</b>
	<p><b>Unprotected rotating coupling</b> Risk of injury by rotating shafts!</p> <ul style="list-style-type: none"> <li>▷ Always operate the pump set with a coupling guard.</li> <li>If the customer specifically requests not to include a coupling guard in PUMPIRAN's delivery, then the operator must supply one!</li> <li>▷ Observe all relevant regulations for selecting a coupling guard.</li> </ul>

6. Reinstall the coupling guard and step guard, if any.
7. Check the distance between coupling and coupling guard.  
The coupling guard must not touch the coupling.

	<b>⚠ DANGER</b>
	<p><b>Risk of ignition by frictional sparks</b> Explosion hazard!</p> <ul style="list-style-type: none"> <li>▷ Choose a coupling guard material that is non-sparking in the event of mechanical contact (see DIN EN 13463-1).</li> </ul>

## 5.8 Electrical connection

	<b>⚠ DANGER</b>
	<p><b>Incorrect electrical installation</b> Explosion hazard!</p> <ul style="list-style-type: none"> <li>▷ For electrical installation, also observe the requirements of IEC 60079-14.</li> <li>▷ Always connect explosion-proof motors via a motor protection switch.</li> </ul>

	<b>⚠ DANGER</b>
	<p><b>Work on the pump set by unqualified personnel</b> Danger of death from electric shock!</p> <ul style="list-style-type: none"> <li>▷ Always have the electrical connections installed by a trained electrician.</li> <li>▷ Observe regulations IEC 30364 (DIN VDE 0100) and, for explosion-proof pump sets, IEC 60079 (DIN VDE 0165).</li> </ul>

	<b>⚠ WARNING</b>
	<p><b>Incorrect connection to the mains</b>                  Damage to the mains network, short circuit!</p> <p>▷ Observe the technical specifications of the local energy supply companies.</p>

1. Check the available mains voltage against the data on the motor name plate.
2. Select an appropriate start-up method.



	<b>NOTE</b>
	<p>It is recommended to fit a motor protection device.</p>

### 5.8.1 Connecting the motor

	<b>NOTE</b>
	<p>In compliance with DIN VDE 0530 - Part 8, three-phase motors are always wired for clockwise rotation (looking at the motor shaft stub). The pump's direction of rotation is indicated by an arrow on the pump.</p>

1. Change the motor's direction of rotation to match that of the pump.
2. Observe the manufacturer's product literature supplied with the motor.

### 5.9 Checking the direction of rotation

 	<b>⚠ DANGER</b>
	<p><b>Temperature increase resulting from contact between rotating and stationary components</b>                  Explosion hazard!                  Damage to the pump set!</p> <p>▷ Never check the direction of rotation by starting up the unfilled pump set.</p> <p>▷ Separate the pump from the motor to check the direction of rotation.</p>

	<b>⚠ WARNING</b>
	<p><b>Hands or objects inside the pump casing</b>                  Risk of injuries, damage to the pump!</p> <p>▷ Never insert your hands or any other objects into the pump.</p> <p>▷ Check that the inside of the pump is free from any foreign objects.</p>

	<b>CAUTION</b>
	<p><b>Incorrect direction of rotation of model with auxiliary impeller (inducer)</b> Damage to the pump!</p> <p>▷ Separate the pump from the motor to check the direction of rotation.</p>

	<b>CAUTION</b>
	<p><b>Motor and pump running in the wrong direction of rotation</b> Damage to the pump!</p> <p>▷ Refer to the arrow indicating the direction of rotation on the pump.</p> <p>▷ Check the direction of rotation. If required, interchange any two phases to correct the direction of rotation.</p>

The correct direction of rotation of motor and pump is in clock-wise direction (seen from the motor end).

1. Start the pump set and stop it again immediately to determine the motor's direction of rotation.
2. Check the direction of rotation.  
The motor's direction of rotation must match the arrow indicating the direction of rotation on the pump.
3. If the direction of rotation is incorrect, check the connection of the motor and the switchgear, if any.

## 6 Commissioning/Start-up/Shutdown

### 6.1 Commissioning/start-up

#### 6.1.1 Prerequisites for commissioning/start-up

Before starting up the pump set make sure that the following requirements are met:

The pump set has been properly connected to the electric power supply and is equipped with all protection devices.

The pump has been primed with the fluid to be handled.

The direction of rotation has been checked. (⇒ Section 5.9 Page 30)

All auxiliary connections required are connected and operational.

The lubricants have been checked.

#### 6.1.2 Filling in the lubricant

**Oil-lubricated bearings** Fill the bearing bracket with lubricating oil.  
Oil quality(⇒ Section 7.2.3.1.2 Page 47)





### NOTE

On un cooled bearing brackets, first remove the reservoir of the constant-level oiler. Then screw in the connection elbow separately.

### Filling the constant- level oiler with lubricating oil (oil bath lubricated bearings only )

The constant-level oiler is screwed into the upper tapping hole of the bearing bracket.



### NOTE

If no constant-level oiler is provided on the bearing bracket, the oil level can be read in the middle of the oil level sight glass arranged at the side of the bearing bracket.



### CAUTION

**Insufficient lubricating oil in the reservoir of the constant-level oiler**  
Damage to the bearings!

- ▷ Regularly check the oil level.
- ▷ Always fill the oil reservoir completely.
- ▷ Keep the oil reservoir properly filled at all times.

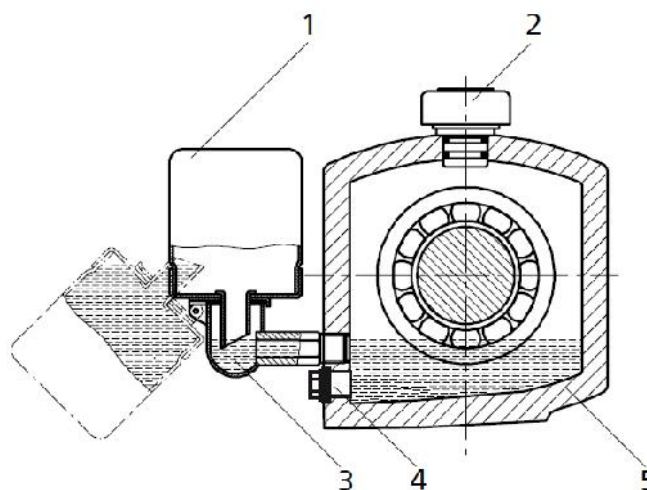

**Fig. 9:** Bearing bracket with constant-level oiler

1	Constant-level oiler	2	Vent plug
3	Connection elbow of constant-level oiler	4	Screwed plug
5	Bearing bracket		

1. Remove the protective cage.
2. Unscrew the vent plug (2).

3. Hinge down the reservoir of the constant-level oiler (1) from the bearing bracket (5) and hold in this position.
4. Pour in the oil through the vent plug tapping hole until oil appears in the connection elbow of the constant-level oiler (3).
5. Fill the reservoir of the constant-level oiler (1) with oil up to the maximum level.
6. Snap the reservoir of the constant-level oiler (1) back into operating position.
7. Screw the vent plug (2) back in.
8. Fit the protective cage.
9. After approximately 5 minutes, check the oil level in the reservoir of the constant-level oiler (1).

It is important to keep the reservoir properly filled at all times, to ensure an optimum oil supply. Repeat steps 1 - 8, if necessary.

10. To verify the correct function of the constant-level oiler (1), slowly drain oil through the drain plug (4) until air bubbles can be seen in the oiler.



## NOTE

An excessively high oil level can lead to a temperature rise and to leakage of the fluid handled or oil.

### 6.1.3 Shaft seal

Shaft seals are fitted prior to delivery.

Observe the instructions on dismantling (⇒Section 7.4.6 Page 51) or reassembly (⇒Section 7.5.3 Page 54) .

#### **Reservoir of non-pressurised external fluid**

If applicable, fill the reservoir of non-pressurised external fluid in accordance with the general arrangement drawing.



#### **Double-acting mechanical seal**



Prior to starting up the pump, apply barrier pressure as specified in the general arrangement drawing.

#### **External liquid feed**

Apply the quantities and pressures specified in the data sheet and the general arrangement drawing.

## 6.1.4 Filling and venting the pump

	 <b>DANGER</b>
	<p><b>An explosive atmosphere forms inside the pump</b> Explosion hazard!</p> <ul style="list-style-type: none"> <li>▷ The pump internals in contact with the fluid to be handled, including the seal chamber and auxiliary systems must be filled with the fluid to be handled at all times.</li> <li>▷ Provide sufficient inlet pressure.</li> <li>▷ Provide an appropriate monitoring system.</li> </ul>

	 <b>DANGER</b>
	<p><b>Shaft seal failure caused by dry running</b> Hot or toxic fluid could escape! Damage to the pump!</p> <ul style="list-style-type: none"> <li>▷ Before starting up the pump set, vent the pump and suction line and fill both with the fluid to be handled.</li> </ul>

1. Vent the pump and suction line and fill both with the fluid to be handled.
2. Fully open the shut-off element in the suction line.
3. Fully open all auxiliary connections (barrier fluid, flushing liquid, etc).

### 6.1.5 Final check

1. Remove the coupling guard and step guard, if any.
2. Check the coupling alignment; re-align the coupling, if required.
3. Check that the coupling and shaft can easily be rotated by hand.
4. Re-install the coupling guard and step guard, if any.
5. Check the distance between coupling and coupling guard.  
The coupling guard must not touch the coupling.

### 6.1.6 Water cooling

	<b>CAUTION</b>
	<p><b>Deposit forming, aggressive cooling water</b> Damage to the pump!</p> <ul style="list-style-type: none"> <li>▷ Observe the cooling water quality.</li> </ul>

Observe the following quality data of the cooling water:

Not deposit forming

Not aggressive

Free from suspended solids

Hardness on average 5 °dH (~1mmol/l)

pH > 8

Conditioned and neutral with regard to mechanical corrosion

Inlet temperature  $t_E = 10$  to  $30$  °C

Outlet temperature  $t_A =$  maximum  $45$  °C

### 6.1.7 Cooling of the pump

The casing cover, the bearing bracket and the casing support on the baseplate can be cooled.

Observe the following quality data of the cooling water:

Maximum permissible cooling liquid pressure: 10 bar

Maximum permissible cooling liquid test pressure: 15 bar

Observe the specified cooling liquid quantity.

### 6.1.8 Cooling of the shaft seal



#### CAUTION

**The vaporisation pressure of the fluid handled is higher than the atmospheric pressure**

Damage to the shaft seal/pump!

▷ Cool the shaft seal.

▷ Provide sufficient quantities of cooling liquid (see table).



#### NOTE

The vaporisation pressure varies depending on the fluid handled, the system pressure and the material of the shaft seal (e.g. hot water).

**Table 10:** Cooling liquid quantities:

	Fluid temperature [°C]	Cooling liquid quantities [m <sup>3</sup> /h] <sup>7)</sup>
Casing cover	< 250	0.3
	< 400	0.6
Bearing bracket	200 <sup>8)</sup> /250 to 315 <sup>9)</sup>	0.2
	> 315 <sup>10)</sup>	
Support on base plate	> 250	0.2

## 6.1.9 Heating

	<b>⚠ DANGER</b>
	<p><b>Excessive surface temperature</b> Explosion hazard! Burns!</p> <p>▷ Observe the permissible temperature classes. (⇒ Section 2.10.2 Page 11)</p>

	<b>CAUTION</b>
	<p><b>Time for warming up the pump too short</b> Damage to the pump!</p> <p>▷ Check that the pump is sufficiently warmed up throughout.</p>

The casing cover can be heated with hot water or steam. Observe the following data for the heating medium:

Maximum permissible temperature  $t = 150\text{ °C}$   
Maximum permissible pressure  $p = 10\text{ bar}$

Seal casing cover with O-rings made of EP.

	<b>CAUTION</b>
	<p><b>Lack of heating medium</b> Damage to the pump!</p> <p>▷ Provide sufficient quantities of a suitable heating medium.</p>

7) The cooling liquid quantities indicated are based on  $t = \max. 15\text{ °C}$ .

8) For  $n = 3500\text{ rpm}$  and  $n = 2900\text{ rpm}$  in conjunction with triple bearing assembly. In all other cases from  $250\text{ °C}$ !

9) Water cooling or fan wheel

10) Water cooling (and fan wheel optional)

The casing cover can be heated with hot water or steam. Observe the following data for the heating medium:

- Maximum permissible temperature  $t = 150\text{ °C}$
- Maximum permissible pressure  $p = 40\text{ bar}$
- Seal casing cover with O-rings made of EP.

	<b>CAUTION</b>
	<p><b>Lack of heating medium</b> Damage to the pump!</p> <p>▷ Provide sufficient quantities of a suitable heating medium.</p>

### 6.1.10 Heating up/keeping warm the pump (set)

	<b>CAUTION</b>
	<p><b>Pump blockage</b> Damage to the pump!</p> <p>▷ Prior to pump start-up, heat up the pump as described in the manual.</p>

Observe the following when heating up the pump (set) and keeping it warm:  
Make sure the temperature is increased continuously.

Max. heating speed:  $10\text{ °C/min}$  ( $10\text{ K/min}$ )

If the pump is used for handling fluids with fluid temperatures exceeding  $150\text{ °C}$ , make sure that the pump has been heated throughout before starting it up

The temperature difference between the pump's surface and the fluid handled must not exceed  $100\text{ °C}$  ( $100\text{ K}$ ) when the pump is started up.

**Fluid temperatures  
above  $150\text{ °C}$**

**Temperature difference**

### 6.1.11 Start-up

	<b>⚠ DANGER</b>
	<p><b>The permissible pressure and temperature limits will be exceeded if the pump is operated with the suction and discharge lines closed.</b> Explosion hazard! Leakage of hot or toxic fluids!</p> <p>▷ Never operate the pump with the shut-off elements in the suction line and/or discharge line closed.</p> <p>▷ Only start up the pump set with the discharge side gate valve slightly or fully open.</p>

	<b>⚠ DANGER</b>
	<p><b>Excessive temperatures due to dry running or excessive gas content in the fluid handled</b>                  Explosion hazard!                  Damage to the pump set!</p> <ul style="list-style-type: none"> <li>▷ Never operate the pump set without liquid fill.</li> <li>▷ Prime the pump as specified. (⇒Section 6.1.4 Page 34)</li> <li>▷ Always operate the pump within the permissible operating range.</li> </ul>

	<b>CAUTION</b>
	<p><b>Abnormal noises, vibrations, temperatures or leakage</b>                  Damage to the pump!</p> <ul style="list-style-type: none"> <li>▷ Switch off the pump (set) immediately.</li> <li>▷ Eliminate the causes before returning the pump set to service.</li> </ul>

The piping system connected to the pump set has been cleaned.

Pump, suction line and inlet tank, if any, have been vented and filled with the fluid to be pumped.

The filling and venting lines have been closed.

	<b>CAUTION</b>
	<p><b>Start-up against open discharge line</b>                  Overloading of the motor!</p> <ul style="list-style-type: none"> <li>▷ Use a soft starter.</li> <li>▷ Use speed control.</li> <li>▷ Make sure the power reserve of the motor is sufficient.</li> </ul>

1. Fully open the shut-off valve in the suction head/suction lift line.
2. Close or slightly open the shut-off valve in the discharge line.
3. Switch on the motor.
4. Immediately after the pump has reached full rotational speed, slowly open the shut-off valve in the discharge line and adjust it to comply with the duty point.



## **⚠ DANGER**

### **Seal leakage at operating temperature**

Hot or toxic fluid may escape!

- ▷ Once the operating temperature has been reached, re-tighten the hexagon nuts at the casing/discharge cover.
- ▷ Check the coupling alignment. Re-align the coupling if required.

5. When the operating temperature has been reached and/or in the event of leakage, switch off the pump set and let it cool down. Then retighten the bolts between lantern and casing.
6. Check the coupling alignment and re-align the coupling if required.

### **6.1.12 Checking the shaft seal**

**Mechanical seal** The mechanical seal only leaks slightly or invisibly (as vapour) during operation. Mechanical seals are maintenance-free.

### **6.1.13 Shutdown**

The shut-off element in the suction line is and remains open.

On pump sets with double-acting mechanical seal, apply the required pressure specified in the general arrangement drawing to the mechanical seal chamber also during standstill.

Also ensure quench liquid supply during pump standstill.

1. Close the shut-off element the discharge line.
2. Switch off the motor and make sure the pump set runs down smoothly to a standstill.



## **NOTE**

If the discharge line is equipped with a non-return or check valve, the shut-off element may remain open if there is back pressure.



## **NOTE**

If shut-off is not possible, the pump will run in reverse direction. The reverse runaway speed must be lower than the rated speed.

For prolonged shutdown periods:

1. Close the shut-off element in the suction line.
2. Close the auxiliary connections.
  - If the fluid to be pumped is fed in under vacuum, also supply the shaft seal with barrier fluid during standstill.
  - Only turn off the cooling liquid supply after the pump has cooled down.



	<b>CAUTION</b>
	<p><b>Risk of freezing during prolonged pump shutdown periods</b>                  Damage to the pump!</p> <p>▷ Drain the pump and the cooling/heating chambers (if any) or otherwise protect them against freezing.</p>

## 6.2 Operating limits

	<b>⚠ DANGER</b>
	<p><b>Non-compliance with application limits for pressure, temperature and speed</b>                  Explosion hazard!                  Hot or toxic fluid may escape!</p> <p>▷ Comply with the operating data indicated in the data sheet.</p> <p>▷ Avoid prolonged operation against a closed shut-off valve.</p> <p>▷ Never operate the pump at temperatures exceeding those specified in the data sheet or on the name plate unless the written consent of the manufacturer has been obtained.</p>

### 6.2.1 Ambient temperature

Observe the following parameters and values during operation:

**Table 11:** Permissible ambient temperatures

Permissible ambient temperature	Temperature
Maximum	43 °C
Minimum	See data sheet

	<b>CAUTION</b>
	<p><b>Operation outside the permissible ambient temperature</b>                  Damage to the pump (set)!</p> <p>▷ Observe the specified limits for permissible ambient temperatures.</p>

## 6.2.2 Frequency of starts

**⚠ DANGER**

**Excessive surface temperature of the motor**  
Explosion hazard!  
Damage to the motor!

▷ In case of explosion-proof motors, observe the switching frequency specified in the manufacturer's product literature.

The frequency of starts is usually determined by the maximum temperature increase of the motor. This largely depends on the power reserves of the motor in steady state operation and on the starting conditions (d.o.l., star-delta, moments of inertia, etc). If the start-ups are evenly spaced over the period indicated, the following limits can be used for orientation for start-up with the discharge-side gate valve slightly open:

**Table 12:** Frequency of starts

Motor rating [kW]	Maximum No. of start-ups [Start-ups/hour]
up to 12	15
up to 100	10
more than 100	5

**CAUTION**

**Re-start while motor is still running down**  
Damage to the pump (set)!

▷ Do not re-start the pump set before the pump rotor has come to a standstill.

## 6.2.3 Flow rate

Unless specified otherwise in the characteristic curves or in the data sheets, the following applies:

$Q_{\max}^{11)}$  see characteristic curves.

$Q_{\min}^{12)} = 0.3 \times Q_{\text{opt}}^{13)}$

The data refer to water and water-like fluids. Longer operating periods with these fluids and at the flow rates indicated will not cause an additional increase in the temperatures on the pump surface. However, if the physical properties of the fluids handled are different from water, the calculation formula below must be used to check if an additional heat build-up may lead to a dangerous temperature increase at the pump surface. If necessary, the minimum flow must be increased.

$$T_0 = T_f + \Delta v$$

$$= \frac{g \cdot H}{c \cdot \eta} * (1 - \eta)$$

11) Maximum permissible flow rate

12) Minimum permissible flow rate

13) Efficiency option

**Table 13: Key**

Symbol	Description	Unit
c	Specific heat capacity	J/kg K
g	Gravitational constant	m/s <sup>2</sup>
H	Pump head	m
T <sub>f</sub>	Temperature of the fluid handled	°C
T <sub>0</sub>	Temperature at the casing surface	°C
	Pump efficiency at duty point	-
	Temperature difference	°C

### 6.2.4 Density of the fluid handled

The power input of the pump increases in proportion to the density of the fluid handled.

	<b>CAUTION</b>
	<p><b>Excessive density of the fluid handled</b> Motor overload!</p> <ul style="list-style-type: none"> <li>▷ Observe the information on fluid density indicated in the data sheet.</li> <li>▷ Make sure the power reserve of the motor is sufficient.</li> </ul>

### 6.2.5 Abrasive fluids

Do not exceed the maximum permissible solids content specified in the data sheet. When the pump handles fluids containing abrasive substances, increased wear of the hydraulic system and the shaft seal are to be expected. In this case, reduce the intervals commonly recommended for servicing and maintenance.

## 6.3 Shutdown/storage/preservation

### 6.3.1 Measures to be taken for shutdown

#### The pump ( set ) remains installed

Sufficient fluid is supplied for the operation check run of the pump.

1. Start up the pump (set) regularly once a month or once every three months for approximately five minutes during prolonged shutdown periods.  
This will prevent the formation of deposits within the pump and the pump intake area.

#### The pump ( set ) is removed from the pipe and stored

The pump has been properly drained (⇒Section 7.3 Page 48) and the safety instructions for dismantling the pump have been observed.  
(⇒Section 7.4.1 Page 49)

1. Spray-coat the inside wall of the pump casing, and in particular the impeller clearance areas, with a preservative.
2. Spray the preservative through the suction and discharge nozzles.  
It is advisable to then close the pump nozzles (e.g. with plastic caps or similar).

3. Oil or grease all blank parts and surfaces of the pump (with silicone-free oil and grease, food-approved if required) to protect them against corrosion.

Observe any additional information provided. (⇒Section 3.2 Page 14)

If the pump set is to be stored temporarily, only preserve the wetted components made of low alloy materials. Commercially available preservatives can be used for this purpose. Observe the manufacturer's instructions for application/removal.

Observe any additional instructions and information provided. (⇒Section 3 Page 13)

## 6.4 Returning to service after storage

For returning the pump to service observe the sections on commissioning/start-up (⇒Section 6.1 Page 31) and the operating limits (⇒Section 6.2 Page 40) .



In addition, carry out all servicing/maintenance operations before returning the pump (set) to service. (⇒Section 7 Page 43)

	<b>⚠ WARNING</b>
	<p><b>Failure to re-install or re-activate protective devices</b>                  Risk of personal injury from moving parts or escaping fluid!</p> <p>▷ As soon as the work is complete, re-install and/or re-activate any safety-relevant and protective devices.</p>

	<b>NOTE</b>
	<p>If the pump has been out of service for more than one year, replace all elastomer seals.</p>

## 7 Servicing/Maintenance

### 7.1 Safety regulations

 	<b>⚠ DANGER</b>
	<p><b>Improperly serviced pump set</b>                  Explosion hazard!                  Damage to the pump set!</p> <p>▷ Service the pump set regularly.</p> <p>▷ Prepare a maintenance schedule with special emphasis on lubricants, shaft seal and coupling.</p>

The operator ensures that all maintenance, inspection and installation work is performed by authorised, qualified specialist personnel who are thoroughly familiar with the manual.

	<p><b>⚠ WARNING</b></p>
	<p><b>Pump set started up inadvertently</b> Risk of injury by moving parts!</p> <ul style="list-style-type: none"> <li>▷ Always make sure the electrical connections are disconnected before carrying out work on the pump set.</li> <li>▷ Make sure that the pump set cannot be switched on accidentally.</li> </ul>

	<p><b>⚠ WARNING</b></p>
	<p><b>Fluids posing a health hazard or hot fluids</b> Risk of personal injury!</p> <ul style="list-style-type: none"> <li>▷ Observe all relevant laws.</li> <li>▷ When draining the fluid take appropriate measures to protect persons and the environment.</li> <li>▷ Decontaminate pumps handling fluids posing a health hazard.</li> </ul>



A regular maintenance schedule will help avoid expensive repairs and contribute to trouble-free, reliable operation of the pump (set) with a minimum of maintenance expenditure and work.

	<p><b>NOTE</b></p>
	<p>All maintenance, service and installation work can be carried out by PUMPIRAN Service. Find your contact in the attached "Addresses" booklet or on the Internet at "<a href="http://www.PUMPIRAN.com">www.PUMPIRAN.com</a>".</p>

Never use force when dismantling and reassembling a pump set.

## 7.2 Servicing/inspection

### 7.2.1 Supervision of operation

 	<p><b>⚠ DANGER</b></p>
	<p><b>Excessive temperatures as a result of bearings running hot or defective bearing seals</b> Explosion hazard! Fire hazard! Damage to the pump set!</p> <ul style="list-style-type: none"> <li>▷ Regularly check the lubricant level.</li> <li>▷ Regularly check the rolling element bearings for running noises.</li> </ul>

	<b>CAUTION</b>
	<p><b>Increased wear due to dry running</b> Damage to the pump set!</p> <ul style="list-style-type: none"> <li>▷ Never operate the pump set without liquid fill.</li> <li>▷ Never close the shut-off element in the suction line and/or supply line during pump operation.</li> </ul>

	<b>CAUTION</b>
	<p><b>Excessive fluid temperature</b> Damage to the pump!</p> <ul style="list-style-type: none"> <li>▷ Prolonged operation against a closed shut-off element is not permitted (heating up of the fluid).</li> <li>▷ Observe the temperature limits in the data sheet and in the section on Operating limits. (⇒Section 6.2 Page 40)</li> </ul>

While the pump is in operation, observe and check the following:

The pump must run quietly and free from vibrations at all times.

In case of oil lubrication, ensure the oil level is correct.

Check the shaft seal. (⇒Section 6.1.12 Page 39)

Check the static seals for any leakage.

Check the rolling element bearings for running noises.

Vibrations, noise and an increase in current input occurring during unchanged operating conditions indicate wear.

Check the correct functioning of any auxiliary connections.

Cooling system

Take the pump out of service at least once year to thoroughly clean the cooling system.

Monitor the stand-by pump.

To make sure that the stand-by pumps are ready for operation, start them up once a week.

Keep the stand-by pump warm.

Observe the following conditions to make sure the stand-by pump is operational and kept warm:

- All cooling points are in operation.
- The permissible nozzle forces and moments are not exceeded.
- In extreme cases, contact the manufacturer.

Monitor the bearing temperature.

The bearing temperature must not exceed 90 °C (measured on the outside of the bearing bracket).

	<b>CAUTION</b>
	<p><b>Operation outside the permissible bearing temperature</b>                  Damage to the pump!</p> <p>▷ The bearing temperature of the pump (set) must never exceed 90 °C (measured on the outside of the bearing bracket).</p>

## 7.2.2 Inspection work

	<b>⚠ DANGER</b>
	<p><b>Excessive temperatures caused by friction, impact or frictional sparks</b>                  Explosion hazard!                  Fire hazard!                  Damage to the pump set!</p> <p>▷ Regularly check the coupling guard, plastic components and other guards of rotating parts for deformation and sufficient distance from rotating parts.</p>

### 7.2.2.1 Checking the coupling

Check the flexible elements of the coupling. Replace these parts in due time if there is any sign of wear.

### 7.2.2.2 Checking the clearance gaps

For checking the clearance gaps remove impeller 230, if required. (⇒Section 7.4.5 Page 50).

If the clearance gap is larger than permitted (see the following table), replace casing wear ring 502 and/or impeller wear ring 502.

The clearances given refer to the diameter.

**Table 14:** Clearances between impeller and casing / between impeller and casing cover

Pump size	Inner nominal diameter of the suction-side casing wear ring (rounded) [mm]	Clearance gap (standard) [mm]	Minimum clearance gap to API 610 [mm]	Inner nominal diameter of the discharge side casing wear ring (rounded) [mm]	Casing wear ring (standard) [mm]	Minimum clearance gap to API 610 [mm]
PO2 40-190	80	0.5-0.05	0.33	70	0.5-0.05	0.33
PO2 40-200	65	0.5-0.05	0.33	100	0.5-0.05	0.33
PO2 40-240	95	0.6-0.05	0.35	85	0.6-0.05	0.40
PO2 40-250	85	0.6-0.05	0.35	85	0.6-0.05	0.40
PO2 80-315	140	0.6-0.05	0.40	130	0.6-0.05	0.45
PO2 150-315	215	0.7-0.08	0.48	200	0.7-0.08	0.48

## 7.2.2.3 Cleaning filters

	<b>CAUTION</b>
	<p><b>Insufficient inlet pressure due to clogged filter in the suction line</b> Damage to the pump!</p> <ul style="list-style-type: none"> <li>▷ Monitor contamination of filter with suitable means (e.g. differential pressure gauge).</li> <li>▷ Clean filter in appropriate intervals.</li> </ul>

## 7.2.3 Lubrication and lubricant change of rolling element bearings

	<b>⚠ DANGER</b>
	<p><b>Excessive temperatures as a result of bearings running hot or defective bearing seals</b> Explosion hazard! Fire hazard! Damage to the pump set!</p> <ul style="list-style-type: none"> <li>▷ Regularly check the condition of the lubricant.</li> </ul>

### 7.2.3.1 Oil lubrication

The rolling element bearings are usually lubricated with mineral oil.

#### 7.2.3.1.1 Intervals

**Table 15:** Oil change intervals

Temperature at the bearing	First oil change	All subsequent oil changes <sup>14)</sup>
up to 70 °C	After 300 operating hours	After 8500 operating hours
70 °C - 80 °C	After 300 operating hours	After 4200 operating hours
80 °C - 90 °C	After 300 operating hours	After 2000 operating hours

#### 7.2.3.1.2 Oil quality

**Table 16:** Oil quality

Temperature at the bearing	Properties	
CLP46 lubricating oil to DIN 51517 or HD 20W/20 SAE	Kinematic viscosity at 40 °C	46±4 mm <sup>2</sup> /s
	Flash point (to Cleveland)	+175 °C
	Solidification point (pour point)	-15 °C
	Application temperature <sup>15)</sup>	Higher than permissible bearing temperature

14) At least once a year

15) For ambient temperatures below -10 °C use a different suitable type of lubricating oil. Contact PUMPIRAN.



## 7.2.3.1.3 Changing the oil

	<b>⚠ WARNING</b>
	<p><b>Lubricants posing a health hazard</b> Risk to persons and the environment!</p> <ul style="list-style-type: none"> <li>▷ When draining the lubricant take appropriate measures to protect persons and the environment.</li> <li>▷ Observe all legal regulations on the disposal of liquids posing a health hazard.</li> </ul>

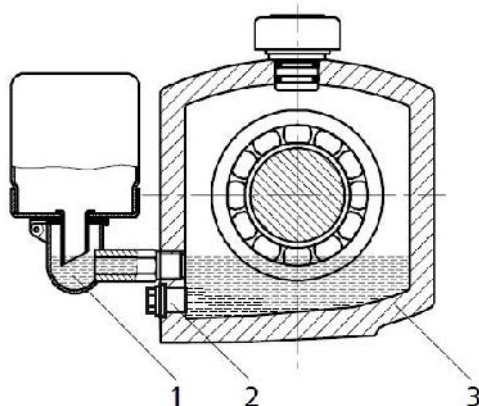

**Fig. 10:** Bearing bracket with constant-level oiler

1	Constant-level oiler	2	Screwed plug
3	Bearing bracket		

A suitable container for the used oil is on hand.

1. Place the container underneath the screwed plug.
2. Undo the screwed plug (2) at the bearing bracket (3) and drain the oil.
3. Once the bearing bracket (3) has been drained, re-insert and re-tighten the screwed plug (2).
4. Re-fill with oil.

## 7.3 Drainage/disposal

	<b>⚠ WARNING</b>
	<p><b>Fluids posing a health hazard</b> Hazardous to persons and the environment!</p> <ul style="list-style-type: none"> <li>▷ Collect and properly dispose of flushing liquid and any fluid residues.</li> <li>▷ Wear safety clothing and a protective mask, if required.</li> <li>▷ Observe all legal regulations on the disposal of fluids posing a health hazard.</li> </ul>

If the fluids handled by the pump (set) leave residues which might lead to corrosion when coming into contact with atmospheric humidity, or which might ignite when coming into contact with oxygen, the pump (set) must be flushed through, neutralised, and blown through with anhydrous gas for drying purposes. Use connection 6B to drain the fluid handled (see auxiliary connections).

## 7.4 Dismantling the pump set

### 7.4.1 General notes/Safety regulations

	<b>⚠ WARNING</b>
	<p><b>Unqualified personnel performing work on the pump (set)</b> Risk of personal injury!</p> <p>▷ Always have repair and maintenance work performed by specially trained, qualified personnel.</p>

	<b>⚠ WARNING</b>
	<p><b>Hot surface</b> Risk of personal injury!</p> <p>▷ Allow the pump set to cool down to ambient temperature.</p>

Observe the general safety instructions and information. (⇒Section 7 Page 43)

For any work on the motor, observe the instructions of the relevant motor manufacturer.

For dismantling and reassembly refer to the general assembly drawing.

In case of damage you can always contact our service staff.

	<b>⚠ DANGER</b>
	<p><b>Insufficient preparation of work on the pump (set)</b> Risk of personal injury!</p> <p>▷ Properly shut down the pump set. (⇒ Section 6.1.13 Page 39)</p> <p>▷ Close the shut-off elements in the suction and discharge line.</p> <p>▷ Drain the pump and release the pump pressure. (⇒ Section 7.3 Page 48)</p> <p>▷ Close any auxiliary connections.</p> <p>▷ Allow the pump set to cool down to ambient temperature.</p>

### 7.4.2 Preparing the pump set

1. Disconnect the power supply (e.g. at the motor).
2. Disconnect and remove all auxiliary pipework.
3. Remove the coupling guard.
4. Remove the coupling spacer, if any.
5. Drain the oil fill of oil-lubricated bearings. (⇒Section 7.2.3.1.3 Page 47)

### 7.4.3 Dismantling the motor



#### NOTE

For pump sets with spacer-type couplings, the back pull-out unit can be removed while the motor remains screwed to the base plate.

1. Disconnect the motor from the power supply.
2. Unbolt the motor from the base plate.
3. Shift the motor to separate it from the pump.



#### ⚠ WARNING

##### Motor tipping over

Risk of squashing hands and feet!

- ▷ Suspend or support the motor to prevent it from tipping over.

### 7.4.4 Removing the back pull-out unit

At pump sets without spacer-type coupling, the motor has been removed.



#### ⚠ WARNING

##### Back pull-out unit tipping over

Risk of squashing hands and feet!

- ▷ Suspend or support the bearing bracket at the pump end.

1. If required, suspend or support bearing bracket 355 to prevent it from tipping over.
2. Remove hexagon nut 920 at volute casing 102.
3. Use forcing screws 901 to pull the back pull-out unit out of volute casing 102.
4. Remove and dispose of joint ring 411.
5. Place the back pull-out unit on a clean and level surface.

### 7.4.5 Dismantling the impeller

#### 7.4.5.1 Removing the impeller — for all bearing bracket sizes

The notes and steps stated in (⇒Section 7.4.1 Page 49) to(⇒Section 7.4.5.1 Page 50) have been observed/carried out.

1. Remove impeller 230 with a puller.
2. Place impeller 230 on a clean and level surface.
3. Remove keys 940 from shaft 210.
4. If throttling bush 542 is fitted, undo grub screws 904.
5. Remove throttling bush 542, if any.

#### 7.4.6 Removing the cartridge seal

The notes and steps stated in (⇒ Section 7.4.1 Page 49) have been observed/carried out.

The back pull-out unit is kept in a clean and level assembly area.

1. If assembling jigs are provided, loosen the hexagon head bolts for fitting the assembling jigs.
2. Engage assembling jigs, if any, in the groove of shaft protecting sleeve 524 and re-tighten the hexagon head bolts.
3. Loosen hexagon head bolts 901 at casing cover 161.
4. Use forcing screws 901 to remove bearing bracket 355.  
At the same time, pull shaft protecting sleeve 524 (if any) with complete cartridge seal 433 off shaft 210.
5. Take care not to damage O-rings 412, if any.
6. Undo hexagon nut 920 and remove seal cover 471 and/or the seal cartridge.  
Observe the seal installation drawing of the mechanical seal.

#### 7.4.7 Dismantling the bearings

The notes and steps stated in (⇒ Section 7.4.1 Page 49) to (⇒ Section 7.4.6 Page 51) have been observed/carried out.

The bearing bracket is kept in a clean and level assembly area.

1. Undo the socket head cap screw in the coupling hub.
2. Pull the coupling half off the pump shaft with a puller.
3. Remove key 940.
4. Remove fan hood 882, fan hub and ventilator impeller 831, if any.
5. Undo hexagon nut 920 and remove seal cover 471 and/or the seal cartridge.
6. Undo grub screws 904 and remove throwers 507.
7. Undo socket head cap screws 914 and remove pump-end bearing cover 360 as well as joint ring 400.
8. Undo hexagon head bolts 901 and remove motor-end bearing cover 360 as well as O-ring 412, if required.
9. Carefully drive shaft 210 together with angular contact ball bearing 321 and the inner ring of cylindrical roller bearing 322, including oil thrower 508, if any, out of the bearing bracket towards the drive end.
10. Remove cylindrical roller bearing 322 (roller cage) from bearing bracket 355.
11. Heat up the inner ring of cylindrical roller bearing 322 to 80 °C, and pull it off the shaft.
12. If oil thrower 508 is fitted, remove grub screw 904 and pull the oil thrower off the shaft.
13. Bend open lockwasher 931 behind keywayed nut 920 on shaft 210.
14. Unscrew keywayed nut 920 (right-hand thread) and remove lockwasher 931.
15. Heat up angular contact ball bearing 321 and the inner ring of cylindrical roller bearing 322 to 80 °C, and pull them off shaft 210.

## 7.5 Reassembling the pump set

### 7.5.1 General notes/Safety regulations

	<b>CAUTION</b>
	<p><b>Improper reassembly</b> Damage to the pump!</p> <ul style="list-style-type: none"> <li>▷ Reassemble the pump (set) in accordance with the general rules of sound engineering practice.</li> <li>▷ Use original spare parts only.</li> </ul>

**Sequence** Always reassemble the pump in accordance with the corresponding general assembly drawing.

**Seal elements**

**Gaskets**

- Always use new gaskets, making sure that they have the same thickness as the old ones.
- Always fit gaskets of asbestos-free materials or graphite without using lubricants (e.g. copper grease, graphite paste).

**O-rings**

- Never use O-rings that have been glued together from material sold by the metre.

	<b>CAUTION</b>
	<p><b>Contact of O-ring with graphite or similar material</b> Fluid could escape!</p> <ul style="list-style-type: none"> <li>▷ Do not coat O-ring with graphite or similar material.</li> <li>▷ Use animal fats or lubricants based on silicone or PTFE.</li> </ul>

**Assembly adhesives**

- For gaskets, avoid the use of assembly adhesives, if possible.
- Should assembly adhesives be required after all, use a commercially available contact adhesive (e.g. "Pattex").
- Only apply adhesive at selected points and in thin layers.
- Never use quick-setting adhesives (cyanoacrylate adhesives).
- Coat the locating surfaces of the individual components and screwed connections with graphite or similar before reassembly.

**Tightening torques** For reassembly, tighten all screws and bolts as specified in this manual.  
(⇒ Section 7.6 Page 55)

### 7.5.2 Fitting the bearings

The individual parts are kept in a clean and level assembly area.

All disassembled parts have been cleaned and checked for wear.

Any damaged or worn parts have been replaced by original spare parts.

The sealing surfaces have been cleaned.

1. Heat up angular contact ball bearing 321 and the inner ring of cylindrical rolling element bearing 322 to approximately 80 °C in an oil bath.
2. Push angular contact ball bearing 321 onto shaft 210 as far as it will go.
3. Push the inner ring of cylindrical roller bearing 322 onto shaft 210 as far as it will go.

**NOTE**

Angular contact ball bearings must be installed in "O" arrangement. Angular contact ball bearings installed in pairs must always be from the same manufacturer.

4. Use a spanner wrench to tighten keywayed nut 920 (right-hand thread) without lockwasher 931.
5. Let angular contact ball bearing 321 cool down to approximately 5 °C above ambient temperature.
6. Re-tighten keywayed nut 920, then unscrew it again.
7. Apply a few spots of a suitable lubricant (e.g. Molykote) to the contact faces of lockwasher 931 and keywayed nut 920.
8. Fit lockwasher 931.
9. Tighten keywayed nut 920.
10. Bend back lockwasher 931.
11. If provided, push oil thrower 508 on shaft 210.
12. Screw grub screw 904 into oil thrower 508.
13. Push cylindrical roller bearing 322 (roller cage) into bearing bracket 355.
14. Carefully push shaft 210 together with angular contact ball bearing 321 and the inner ring of cylindrical roller bearing 322, including oil thrower 508 (if any) into bearing bracket 355 towards the pump end.
15. Insert O-ring 412 into the groove of motor-end bearing cover 360.
16. Insert motor-end bearing cover 360 with O-ring 412 into bearing bracket 355 from the motor end.
17. Screw hexagon head bolts 901 with bearing cover 360 into bearing bracket 355 from the motor end.
18. Fit pump-end bearing cover 360 with joint ring 400.
19. Screw socket head cap screws 914 into bearing bracket 355.
20. Push thrower 507 onto shaft 210 from the pump end until it sits about 2 mm from pump-end bearing cover 360.
21. Screw grub screw 904 into pump-end thrower 507.
22. Push thrower 507 onto shaft 210 from the pump end until it sits about 2 mm from pump-end bearing cover 360.
23. Screw grub screw 904 into motor-end thrower 507.
24. Fit fan hood 832, fan hub and ventilator impeller 831, if any.
25. Insert key 940 into the keyway at the shaft end from the motor end.
26. Pull the coupling half onto the shaft end.
27. Screw socket head cap screw into the coupling hub.

### 7.5.3 Installing the shaft seal

#### 7.5.3.1 Installing the cartridge seal

Always observe the following points when installing the cartridge seal:

Install the cartridge seal as described in the seal installation drawing.

Work cleanly and accurately.

Prevent any damage to the sealing surfaces or O-rings.

The notes and steps stated in (⇒ Section 7.5.1 Page 52) to (⇒ Section 7.5.2 Page 52) have been observed/carried out.

1. Fit seal cover 471 and/or seal cartridge and tighten hexagon head bolts 901.
2. Push casing cover 161 with cartridge seal 433 onto the shaft from the pump end.
3. Carefully guide complete pre-assembled bearing bracket 355 over the studs 902 which have been screwed into casing cover 161.
4. On cooled versions, make sure not damage O-rings 412 at casing cover 161.
5. Screw casing cover 161 to complete bearing cover 355 with hexagon nuts 901.

### 7.5.4 Fitting the impeller

#### 7.5.4.1 Fitting the impeller — for all bearing bracket sizes

The notes and steps stated in (⇒ Section 7.5.1 Page 52) to (⇒ Section 7.5.3.1 Page 54) have been observed/carried out.

The back pull-out unit is kept in a clean and level assembly area.

The pre-assembly (motor, shaft, bearing bracket, casing cover) is kept in a clean and level assembly area.

All disassembled parts have been cleaned and checked for wear.

Any damaged or worn parts have been replaced by original spare parts.

The sealing surfaces have been cleaned.

1. If applicable, push throttling bush 542 onto impeller 230.
2. Screw grub screws 904 into throttling bush 542.
3. Push joint ring 411 onto shaft 210.
4. Place key 940 into the keyway of shaft 210.
5. Slip impeller 230 onto shaft 210.

### 7.5.5 Installing the back pull-out unit



#### ⚠ WARNING

##### **Back pull-out unit tipping over**

Risk of squashing hands and feet!

- ▷ Suspend or support the bearing bracket at the pump end.

The notes and steps stated in (⇒Section 7.5.1 Page 52) have been observed/carried out.

Any damaged or worn parts have been replaced by original spare parts.

The sealing surfaces have been cleaned.

For back pull-out units without coupling, install the coupling in accordance with the manufacturer's instructions.

1. If required, prevent the back pull-out unit from tipping over, e.g. by suspending or supporting it. Then push it into volute casing 102 with new gasket 400.
2. Tighten nut 920 at volute casing 102. Observe the tightening torques. ( ⇒ Section 7.6.1 Page 55)

### 7.5.6 Mounting the motor



#### NOTE

Steps 1 and 2 do not apply to versions with spacer-type coupling.

1. Shift the motor to connect it to the pump via the coupling.
2. Fasten the motor to the base plate.
3. Align the pump.
4. Connect the motor to the power supply (refer to manufacturer's product literature).

### 7.6 Tightening torques

#### 7.6.1 Tightening torques of the pump

Use a torque wrench to tighten the screwed connections (901 / 902) between the volute casing and the casing cover.

### 7.7 Spare parts stock

#### 7.7.1 Ordering spare parts

Always quote the following data when order replacement or spare parts:

Type series  
Size  
PUMPIRAN order number  
Material variant  
Year of construction

Refer to the name plate for all data.

Also supply the following data:

Part description  
Part No.  
Quantity of spare parts  
Delivery address



Mode of dispatch (freight, mail, express freight, air freight)  
 Refer to the general assembly drawing for part numbers and descriptions. (⇒Section 9.1 Page 59)

**Also see**

- Name plate [⇒ Page 16]

### 7.7.2 Recommended spare parts stock for 2 years' operation to DIN 24296

**Table 17:** Quantity of spare parts for recommended spare parts stock

Part No.	Description	Number of pumps (including stand-by pumps)						
		2	3	4	5	6 and 7	8 and 9	10 and more
210	Shaft	1	1	1	2	2	2	20%
230	Impeller	1	1	1	2	2	2	20%
321	Angular contact ball bearing (set)	1	1	2	2	2	3	25%
322	Cylindrical roller bearing	1	1	2	2	2	3	25%
355	Bearing bracket	--	--	--	--	--	1	2
502 <sup>24)</sup>	Casing / Impeller wear ring	2	2	2	3	3	4	50%
542	Throttling bush	1	1	2	2	2	3	30%
-	Sealing elements	4	6	8	8	9	10	100%
433	Mechanical seal complete	1	1	2	2	2	3	25%

## 8 Trouble-shooting

- A** Pump delivers insufficient flow rate
- B** Motor overload
- C** Excessive pump discharge pressure
- D** Excessive bearing temperature
- E** Leakage at the pump
- F** Excessive leakage at the shaft seal
- G** Vibrations during pump operation
- H** Excessive rise of temperature inside the pump

24) If any

**Table 18:** Trouble-shooting

A	B	C	D	E	F	G	H	Possible cause	Remedy <sup>25)</sup>
X								Pump delivers against an excessively high discharge pressure.	Re-adjust to duty point. Check system for impurities. Fit a larger impeller. <sup>26)</sup> Increase the speed (turbine, I.C. engine).
X						X	X	Pump or piping are not completely vented or primed.	Vent and/or prime.
X								Supply line or impeller clogged.	Remove deposits in the pump and/or piping.
X								Formation of air pockets in the piping.	Alter piping layout. Fit a vent valve.
X						X	X	Suction head is too high/NPSH <sub>available</sub> (positive suction head) is too low.	Check/alter liquid level. Install pump at a lower level. Fully open the shut-off valve in the suction line. Change suction line if the friction losses in the suction line are too high. Check any strainers installed/suction opening. Observe permissible speed of pressure fall.
X								Air intake at the shaft seal.	Clean barrier fluid duct, supply external barrier fluid, if necessary, or increase barrier fluid pressure. Fit new shaft seal.
X								Wrong direction of rotation.	Interchange two of the phases of the power supply cable.
X								Speed is too low. <sup>26)</sup> - Operation with frequency inverter - Operation without frequency inverter	- Increase voltage/frequency at the frequency inverter in the permissible range. - Check the voltage.
X						X		Impeller	Replace worn components by new ones.
	X					X		Pump back pressure is lower than specified in the purchase order.	Re-adjust to duty point. In the case of persistent overloading, turn down impeller. <sup>26)</sup>
	X							Density or viscosity of the fluid pumped is higher than stated in the purchase order.	Contact PUMPIRAN.
	X	X						Speed is too high.	Reduce speed. <sup>26)</sup>
				X				Defective seal.	Fit new seal between volute casing and discharge cover.

25) Pump pressure must be released before attempting to remedy faults on parts which are subjected to pressure.

26) Request particulars.

A	B	C	D	E	F	G	H	Possible cause	Remedy <sup>25)</sup>
					X			Worn shaft seal.	Fit new shaft seal. Check flushing liquid / barrier fluid.
					X			Vibrations during pump operation.	Correct suction conditions. Re-align the pump. Re-balance the impeller. Increase pressure at the pump suction nozzle.
			X		X	X		The pump set is misaligned.	Re-align.
			X		X	X		Pump is warped or sympathetic vibrations in the piping.	Check pipeline connections and secure fixing of pump; if required, reduce the distances between the pipe clamps. Fix the pipelines using anti-vibration material.
			X			X		Insufficient or excessive quantity of lubricant or unsuitable lubricant.	Top up, reduce or change lubricant.
			X					Non-compliance with specified coupling distance.	Correct distance according to the general arrangement drawing.
X	X							Motor is running on two phases only.	Replace the defective fuse. Check the electric cable connections.
						X		Rotor is out of balance.	Clean the impeller. Re-balance the impeller.
						X		Defective bearing(s)	Fit new bearing(s).
						X	X	Flow rate is too low.	Increase the minimum flow rate.
					X			Incorrect inflow of circulation liquid	Increase the free passage.

25) Pump pressure must be released before attempting to remedy faults on parts which are subjected to pressure.

## 9 Related Documents

### 9.1 General assembly drawing with list of components

#### 9.1.1 PO2 40-250

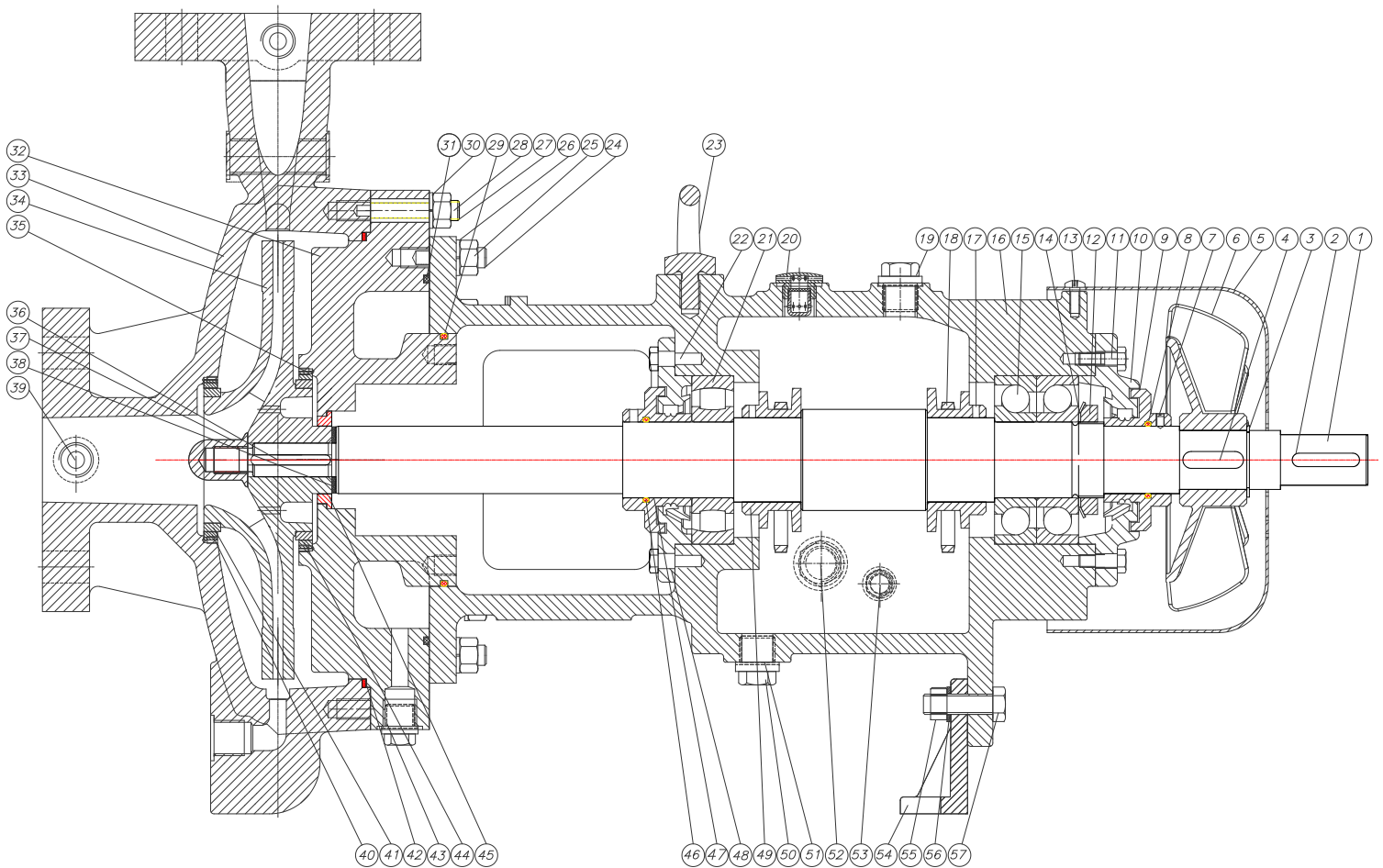

**Fig. 11:** PO2 40-250 – Assembly drawing



#### NOTE

**The shaft is sealed by soft packing or mechanical seal.**

**Table 19: PO2 40-250 – Part list**

No.	Part No	Denomination
1	210	Shaft
2	940	Key
3	932	CirClip
4	940	Key
5	832	Fan Hood
6	831	Ventilator Impeller
7	900	Slotted Cheese Head Screw
8	412	O-Ring
9	423	Labyrinth Seal
10	360	Bearing Cover Drive End
11	901	Hexagon head bolt
12	923	Lock Nut
13	901	Hexagon head bolt
14	931	Lock Washer
15	321	Radial ball bearing
16	355	Bearing bracket
17	900	Slotted Cheese Head Screw
18	500	Oil Ring Flinger
19	903	Screw Plug
20	637	Breather
21	322	Cylindrical Roller Bearing
22	901	Hexagon head bolt
23	520	Lifting Eye Bolt
24	902	Stud
25	920	Hexagon nut
26	930	Spring Washer
27	902	Stud
28	920	Hexagon nut
29	412	O-Ring
30	930	Spring Washer

No.	Part No	Denomination
31	412	O-Ring
32	451	Stuffing Box Housing
33	102	Volute Casing
34	230	Impeller
35	900	Slotted Cheese Head Screw
36	940	Key
37	921	Shaft Nut
38	400	Flat Gasket
39	900	Screw Plug
40	502	Wear Ring
41	502	Wear Ring
42	400	Flat Gasket
43	900	Screw Plug
44	502	Wear Ring
45	457	Neck Ring
46	412	O-Ring
47	423	Labyrinth Seal
48	360	Bearing Cover
49	242	Oil Ring
50	903	Magnetic Plug Screw
51	411	Washer
52	626	Sight Glass
53	638	Constant Level Oiler
54	183	Support foot
55	920	Hexagon nut
56	930	Spring Washer
57	901	Hexagon head bolt

10 EC Declaration of Conformity

Manufacturer:

PUMPIRAN CO. TABRIZ

The manufacturer herewith declares that the pump/pump set:

PO2

PUMPIRAN order number: .....

is in conformity with the provisions of the following directives as applicable in their current version:

- EC Machinery Directive 2006/42/EC

The manufacturer also declares that

the following harmonised international standards were applied:

- ISO 12100-1/A1, ISO 12100-2/A1,
- ISO 14121-1,
- EN 809/A1

Applied national technical standards and specifications, in particular:

- DIN EN ISO 13709

.....

Name

Function

Responsible for compiling the technical documentation

PUMPIRAN CO. TABRIZ



## **Index**

### **A**

**Abrasive fluids 38**

### **B**

**Back pull-out unit 46**

**Bearing temperature 40**

**Bearings 16**

### **C**

**Certificate of decontamination 66**

**Clearance gaps 41**

**Commissioning/start-up 29**

**Constant-level oiler 29**

**Coupling 41**

### **D**

**Design 15, 18**

**Designation 15**

**Direction of rotation 27**

**Dismantling 45**

**Disposal 14**

### **E**

**Explosion protection 11, 20, 24, 25, 26,  
27, 31, 33, 34,36, 39, 41, 43**

### **F**

**Filling and venting 32**

**Filter 22, 42**

**Final check 32**

**Flow rate 37**

**Frequency of starts 36, 37**

**Function 18**

### **H**

**Heating 33**

**Heating speed 34**

**Heating up 34**



**I**

- Impeller type 16**
- Installation**
- Installation on foundation 20**
- Installation at site 20**
- Intended use 8**
- Interchangeability of pump components 55**

**K**

- Keeping the pump warm 34**

**M**

- Maintenance/ repair 39**
- Mechanical seal 35**
- Misuse 9**
- Monitoring equipment 12**

**N**

- Name plate 15**
- Noise characteristics 18**

**O**

- Oil lubrication**
- Intervals 43**
- Oil quality 43**
- Operating limits 8, 36**
- Order number 6**
- Other applicable documents 6**

**P**

- Partly completed machinery 6**
- Piping 22**
- Preservation 14, 38**
- Product description 15**
- Pump casing 16**

**R**

- Return to supplier 14**
- Returning to service 38**
- Running noises 39, 40**

## **S**

**Safety 8**

**Safety awareness 9**

**Scope of supply 18**

**Shaft seal 16**

**Shutdown 35, 38**

**Spare parts 54**

**Start-up 34**

**Storage 14, 38**

## **T**

**Temperature difference 34**

**Temperature limits 11**

**Tightening torques 51**

**Transport 13**

**Trouble-shooting 58**

## **W**

**Water cooling 32**

[www.pumpiran.com](http://www.pumpiran.com)



**PUMPIRAN**  
Water • Oil • Energy